



2,5-Sitzer mit Armlehne links - Longchair mit Armlehne rechts



Abschlusselement links mit 1-Sitzer - Spitz-Ecke klein - 2-Sitzer mit Armlehne rechts



2-Sitzer mit Armlehne links - Umbauecke medium rechts



Möbel

dgm-moebel.de

H20-40150

... das geprüfte Möbel



www.blauer-engel.de/12148

EMISSIONSKLASSE
für Möbel
Emission class for furniture

Sitzmöbel / Seating furniture
Hersteller / Manufacturer number
H20-40150
Kollektion / Collection / Model / Model
Gesamtkollektion
Produktname / Control number

A	B	C	D	A
---	---	---	---	----------

Emissionsklasse für Möbel nach der
RAL-Regelierung RAL-DE-032
der Gütegemeinschaft Möbel e.
Emission class for furniture
according to RAL-DE-032
www.missionslabel.de



Armlehnen- und Nahtauswahl



Armlehne 1



Armlehne 2



Armlehne 3

Standardnaht



Standardnaht

Kontrastnaht



635 (SH 42 cm)
618 (SH 45 cm)
639 (SH 48 cm)
Chrom glänzend



223 (SH 42 cm)
222 (SH 45 cm)
709 (SH 48 cm)
Chrom matt



893 (SH 42 cm)
192 (SH 45 cm)
710 (SH 48 cm)
Schwarz matt



630 (SH 42 cm)
596 (SH 45 cm)
673 (SH 48 cm)
Chrom glänzend



753 (SH 42 cm)
754 (SH 45 cm)
819 (SH 48 cm)
Chrom glänzend



621 (SH 42 cm)
622 (SH 45 cm)
914 (SH 48 cm)
Holzfuß



747 (SH 42 cm)
748 (SH 45 cm)
916 (SH 48 cm)
Holzfuß



858 (SH 42 cm)
879 (SH 45 cm)
913 (SH 48 cm)
Holzfuß

Funktionen



Lederteilung bei Longchair XL



Rückentiefenverstellung (RTV)



Querschläfer



Stauraum







Multifunktionskopfstütze



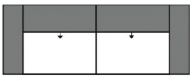

Alle Artikel auf einen Blick

(ohne Typen mit Funktion und Zubehör)

Einzelelemente mit zwei Armlehnen mit Rückenverstellung

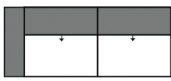
					
3-Sitzer mit 2 Armlehnen	2,5-Sitzer mit 2 Armlehnen	2-Sitzer mit 2 Armlehnen	2-Sitzer medium mit 2 Armlehnen		
180 cm + 2 AL	160 cm + 2 AL	140 cm + 2 AL	120 cm + 2 AL		



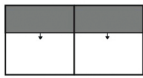
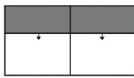
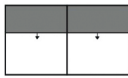

Einzelelemente mit AL links / rechts mit Rückenverstellung

					
3-Sitzer mit Armlehne links / rechts	2,5-Sitzer mit Armlehne links / rechts	2-Sitzer mit Armlehne links / rechts	2-Sitzer medium mit Armlehne links / rechts		
180 cm + AL	160 cm + AL	140 cm + AL	120 cm + AL		

Einzelelemente ohne Armlehnen mit Rückenverstellung

					
3-Sitzer ohne Armlehnen	2,5-Sitzer ohne Armlehnen	2-Sitzer ohne Armlehnen	2-Sitzer medium ohne Armlehnen		
180 cm	160 cm	140 cm	120 cm		

Sondertypen ohne Armlehnen mit Rückenverstellung (inklusive 4



					
1,5-Sitzer ohne Armlehnen	1,5-Sitzer medium ohne Armlehnen	1-Sitzer ohne Armlehnen	1-Sitzer medium ohne Armlehnen		
90 cm	80 cm	70 cm	60 cm		

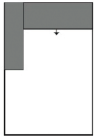
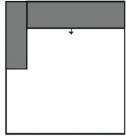
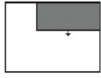
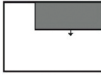

Basiselemente mit Rückenverstellung



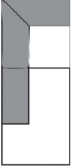
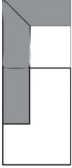

					
Longchair mit Armlehne links / rechts	Longchair XL mit Armlehne links / rechts	Abschlusselement links / rechts + 1-Sitzer	Abschlusselement links / rechts + 1-Sitzer		
AL + 80 cm x 185 cm	AL + 120 cm x 185 cm	100 cm	120 cm		

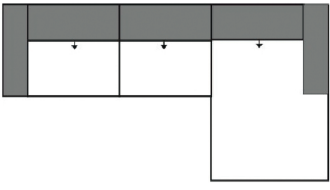

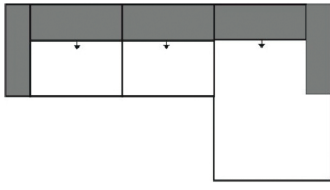

Alle Artikel auf einen Blick

(ohne Typen mit Funktion und Zubehör)

Basiselemente (Rücken fest)					
					
Umbauecke medium links / rechts	Umbauecke links / rechts	Spitz - Ecke klein			
100 x 202 cm	100 x 222 cm	100 x 100 cm			

Maße (ca. cm) Höhe 82/85/88 Tiefe 102 Sitzhöhe 42/45/48 Sitztiefe 56-70			
	Art.-Nr. 6780(Abb.) / 6781(spiegelbildl.)	Art.-Nr. 6756(Abb.) / 6757(spiegelbildl.)	Art.-Nr. 6764(Abb.) / 6765(spiegelbildl.)
Maße	AL + 240 cm x 185 cm	AL + 240 cm x 202 cm	2 AL + 220 cm x 185 cm
	2,5-Sitzer mit Armlehne links mit manueller RTV - Longchair mit Armlehne rechts mit manueller RTV	2-Sitzer mit Armlehne links mit manueller RTV - Umbauecke medium rechts	2-Sitzer mit Armlehne links mit manueller RTV - Longchair mit Armlehne rechts mit manueller RTV













Maße (ca. cm) Höhe 82/85/88 Tiefe 102 Sitzhöhe 42/45/48 Sitztiefe 56-70				
	Art.-Nr. 7854	Art.-Nr. 8097	Art.-Nr. 7853	Art.-Nr. 8096
Maße	70 x 70 cm	70 x 70 cm	90 x 60 cm	90 x 60 cm
	Hocker	Hocker mit Stauraum	Hockerbank	Hockerbank mit Stauraum

Maße (ca. cm) Höhe 82/85/88 Tiefe 102 Sitzhöhe 42/45/48 Sitztiefe 56-70				
	Art.-Nr. 7890	Art.-Nr. 9372	Art.-Nr. 8095	Art.-Nr. 9576
Maße	50 x 17 x 13 cm	64 x 17 x 13 cm	50 x 30 x 17 cm	52 x 30 x 25 cm
	Kopfstütze	Kopfstütze groß	Komfortkopfstütze	Multifunktionskopfstütze

Zubehör

Alle Kissen werden immer mit Standardnaht geliefert!

Die Komfort - Kopfstütze wird immer mit Standardnaht geliefert!

Maße (ca. cm) Höhe 82/85/88 Tiefe 102 Sitzhöhe 42/45/48 Sitztiefe 56-70				
Art.-Nr.	7804	7805	7806	9295
Maße	40 x 40 cm	50 x 50 cm	60 x 60 cm	60 x 40 cm
	Spitzkissen	Spitzkissen	Spitzkissen	Spitzkissen
Maße (ca. cm) Höhe 82/85/88 Tiefe 102 Sitzhöhe 42/45/48 Sitztiefe 56-70				
Art.-Nr.	7809	7644	7645	7646
Maße	50 x 40 cm	55 x 25 cm	65 x 25 cm	75 x 25 cm
	Armlehnenkissen	Nierenkissen (SR 60)	Nierenkissen (SR 70)	Nierenkissen (SR 80)
Maße (ca. cm) Höhe 82/85/88 Tiefe 102 Sitzhöhe 42/45/48 Sitztiefe 56-70				
Art.-Nr.	7647	7689	7546	7545
Maße	85 x 25 cm	115 x 25 cm	75 x 75 cm	95 x 95 cm
	Nierenkissen (SR 90)	Nierenkissen (SR 120)	Flutterkissen quadratisch M	Flutterkissen quadratisch L
Preise in EUR				



...aus geprüften Möbel

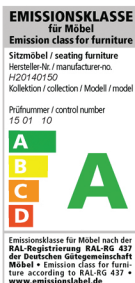

www.blauer-engel.de/uz148



Longlife
by 3C Care

