

01.

Sedute /Seating
2024

Indice /Index

Company profile	004
Indice per tipologie /Category index	014
Legenda /Key	021
Sedie + Sgabelli /Chairs + Stools	022
Sedute lounge /Lounge seating	296



Tutto ha inizio da una sedia in legno con la seduta impagliata, la Marocca. È il 1923 e Antonio Calligaris fonda a Manzano, in Italia, un'azienda destinata a diventare un marchio conosciuto in tutto il mondo. Di generazione in generazione, Calligaris si trasforma in un'industria moderna e internazionale. Oggi che ha superato il secolo di vita, continua a raccontare con i suoi prodotti una storia di innovazione, saper fare e design italiano.

It all starts with a wooden chair featuring a woven seat, the Marocca. It is 1923, and Antonio Calligaris founds a company in Manzano, Italy, destined to become a globally recognized brand. From generation to generation, Calligaris evolves into a modern and international industry. Today, after a century of existence, it continues to tell a story of innovation, know-how, and Italian design through its products.

Calligaris, dal 1923 /Since 1923

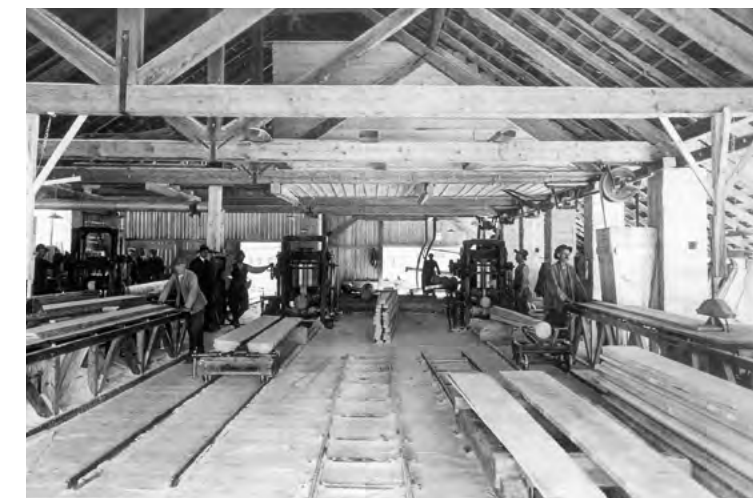

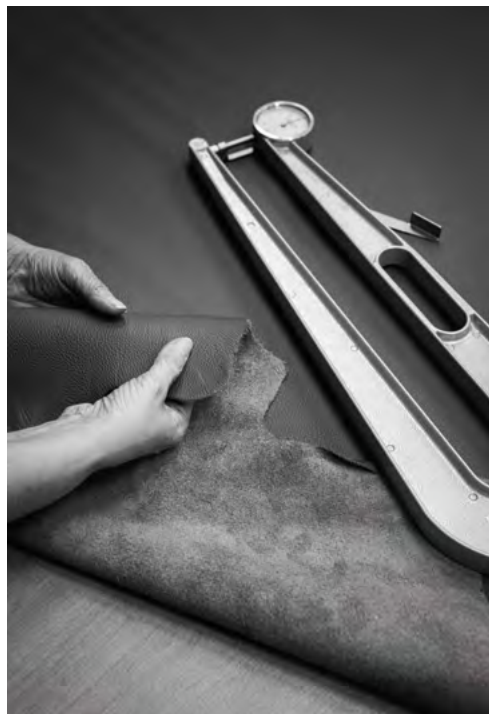

Calligaris è testimone di un secolo di saper fare. Dalla tradizione artigianale delle origini alla meccanizzazione degli anni Settanta, fino alla consolidata forza industriale di cui gode oggi, l'azienda ha sempre interpretato la produzione di arredamento come un progetto capace di coniugare estetica e funzionalità, passato e presente, eccellenza e qualità.

Calligaris is witness to a century of know-how. From the artisanal tradition of its origins, to the mechanization of the 1970s, to the consolidated industrial strength it enjoys today, the company has always interpreted furniture production as a project that combines look and functionality, past and present, excellence and quality.

Saper fare,
ancora
/Know-how,
still



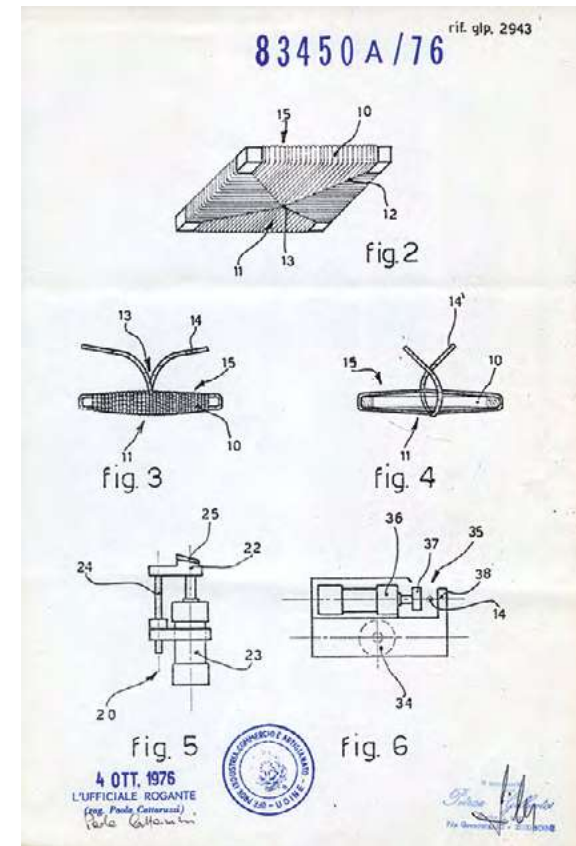



La capacità di abbracciare il cambiamento è la caratteristica più duratura del marchio Calligaris, e l'ingegno il pilastro su cui si basa la sua spinta all'innovazione. Punta di diamante sono i meccanismi di allunga dei tavoli. Semplici, eppure estremamente ingegnosi, i meccanismi sono la migliore dimostrazione dell'attitudine di Calligaris a offrire soluzioni innovative per la vita di tutti i giorni.

The ability to embrace change is the most enduring characteristic of the Calligaris brand, and ingenuity is the pillar that supports its drive for innovation. A highlight of this are the extension mechanisms of its tables. Simple yet extremely ingenious, these mechanisms are the best demonstration of Calligaris' aptitude for offering innovative solutions for everyday life.

Questione d'ingegno /A matter of ingenuity





Archirivolto



Bernhardt & Vella



Gabriele & Oscar Buratti



Busetti Garuti Redaelli



Carlesi Tonelli



Gino Carollo

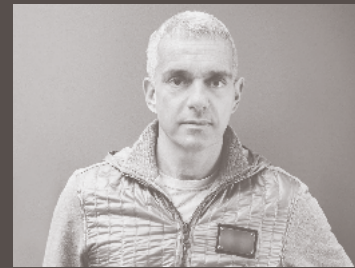

Stefano Cavazzana



Edi & Paolo Ciani



Matteo Cibic



Daniele Lo Scalzo Moscheri



E-ggs



Kaschkasch



Michele Menescardi



MrSmith Studio



Pininfarina



Radice Orlandini



Luca Roccadadria



Stefano Spessotto



Pio & Tito Toso



















































Hanne Willmann

Il design è l'essenza di Calligaris, che può vantare nel corso degli anni numerose collaborazioni con designer di talento. Nell'interpretare i prodotti dell'azienda i designer hanno innestato le loro idee su un nucleo solido, che ha da sempre come obiettivo quello di offrire risposte per la vita reale. Sedie, tavoli, mobili, divani e letti diventano così espressione dell'incontro perfetto tra creatività e funzionalità, oltre che del design italiano.

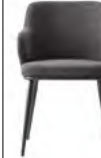
Design is the essence of Calligaris, which has proudly collaborated with many talented designers over the years. By interpreting the company's products, the designers have infused their ideas into a solid core, which has always had the goal of offering solutions for real life. Chairs, tables, furniture, sofas, and beds thus become expressions of the perfect blend of creativity and functionality, as well as Italian design.

Design italiano /Italian design

 Anime p. 054 CS2210 CS2210-MTO	 Carmen Large p. 094 CS2209 CS2209-MTO	 Fifties p. 126 CS1854-A-MTO	 Holly Fab p. 180 CS2212 CS2212-MTO	 Sweel p. 280 CS2211 CS2211-MTO CS2211-BI MTO
 Abrey p. 024 CS2040 CS2040-MTO	 Abrey p. 024 CS2041 CS2041-MTO	 Adèl p. 032 CS2095 CS2095-MTO	 Adèl p. 032 CS2096 CS2096-MTO	 Adèl p. 032 CS2099 CS2099-MTO
 Adèl p. 032 CS2202	 Aida p. 044 CS1452	 Aida p. 044 CS1452-A CS1452-MTO	 Aida p. 044 CS1484	 Annie p. 064 CS1809 CS1809-MTO
 Annie p. 064 CS1852 CS1852-MTO	 Annie p. 064 CS1846 CS1846-MTO	 Annie p. 064 CS1848 CS1848-MTO	 Annie p. 064 CS1847 CS1847-MTO	 Atollo p. 074 CS5104
 Atollo p. 074 CS5105	 Basil p. 078 CS1348	 Basil p. 078 CS1359	 Basil p. 078 CS1856 180 CS1856 360	 Bess Low p. 088 CS1463 CS1463-MTO

 Bess p. 088 CS1294 CS1294-MTO	 Carmen p. 094 CS2052 CS2052-MTO	 Claire p. 102 CS1443	 Cocoon p. 106 CS2074-MTO	 Cocoon p. 106 CS2076-MTO
 Cocoon p. 106 CS2077-MTO 180 CS2077-MTO 360	 Cocoon p. 106 CS2083 CS2083-BI CS2083-MTO	 Cocoon p. 106 CS2084 CS2084-BI CS2084-MTO	 Cocoon p. 106 CS2085 180 CS2085-BI 180 CS2085-MTO 180	 Cocoon p. 106 CS2085 360 CS2085-BI 360 CS2085-MTO 360
 Etoile p. 116 CS1424 CS1424-MTO	 Etoile p. 116 CS1423 CS1423-MTO	 Fifties p. 126 CS1854 CS1854-MTO	 Foyer p.138 CS1888 CS1888-MTO	 Foyer p.138 CS1889 CS1889-MTO
 Foyer p.138 CS1899 CS1899-MTO	 Foyer p.138 CS2000 CS2000-MTO	 Foyer p.138 CS1896 CS1896-MTO	 Foyer p.138 CS1898 CS1898-MTO	 Foyer p.138 CS1895 CS1895-MTO
 Foyer p.138 CS1897 CS1897-MTO	 Gala p. 154 CS1866 CS1866-MTO	 Gala p. 154 CS1867 CS1867-MTO	 Holly p. 162 CS2080 CS2080-MTO	 Holly p. 162 CS2037 CS2037-MTO



Holly | p. 162

CS2056 180
CS2056 360



Holly Fab | p. 180

CS2206
CS2206-MTO



Igloo | p. 190

CS1810
CS1810-MTO

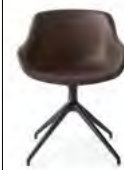

Igloo | p. 190

CS1835-MTO 180
CS1835-MTO 360



Igloo | p. 190

CS1841
CS1841-MTO



Igloo | p. 190

CS1874-MTO 180
CS1874-MTO 360



Inès | p. 198

CS2079
CS2079-MTO



Inès | p. 198

CS2004
CS2004-MTO



Liberty | p. 210

CS1883



Liberty | p. 210

CS1884



Love | p. 216

CS1885
CS1885-A
CS1885-MTO



Oleandro | p. 224

CS2034
CS2034-MTO



Oleandro | p. 224

CS2031
CS2031-MTO



Parisienne | p. 246

CS1263



Romy | p. 254

CS1912
CS1912-MTO



Romy | p. 254

CS1908
CS1908-MTO



Romy | p. 254

CS1906



Saint Tropez | p. 258

CS1855



Saint Tropez | p. 258

CS1845



Saint Tropez | p. 258

CS1858 180
CS1858 360



Skin | p. 268

CS1391



Sophia | p. 276

CS1890
CS1890-MTO



Sweel | p. 280

CS2207
CS2207-MTO
CS2207-BI MTO



Basil | p. 078

CS1857



Cocoon | p. 106

CS2078-MTO



Cocoon | p. 106

CS2086
CS2086-MTO
CS2086-BI



Holly | p. 162

CS2057



Igloo | p. 190

CS1838-MTO



Igloo | p. 190

CS1873-MTO



Saint Tropez | p. 258

CS1859

Sgabelli /Stools



New

Carmen | p. 094

CS2217
CS2217-MTO



New

Fifties | p. 126

CS1864-A MTO



New

Sweel | p. 280

CS2215
CS2215-BI MTO
CS2215-MTO



New

Sweel | p. 280

CS2214
CS2214-BI MTO
CS2214-MTO



Abrey | p. 024

CS2042
CS2042-MTO



Adèl | p. 032

CS2200
CS2200-MTO



Aida | p. 044

CS1821



Aida | p. 044

CS2017
CS2017-MTO



Atollo | p. 074

CS1876

**Basil** | p. 078

CS1495

**Basil** | p. 078

CS1354

**Basil** | p. 078

CS1356

**Bess** | p. 088

CS1445-MTO

**Even Plus** | p. 122

CS1394

**Fifties** | p. 126CS1864
CS1864-MTO**Fifties** | p. 126

CS2007-MTO

**Foyer** | p. 138CS2072
CS2072-MTO**Gala** | p. 154

CS1868-MTO

**Gala** | p. 154

CS1870-MTO

**Holly** | p. 162CS2038
CS2038-MTO**Inès** | p. 198CS2022
CS2022-MTO**Oleandro** | p. 224CS2032
CS2032-MTO**Oleandro** | p. 224CS2035
CS2035-MTO**Palm** | p. 242CS1811
CS1811-MTO**Palm** | p. 242CS1822
CS1822-MTO**Palm** | p. 242CS1827
CS1827-MTO**Saint Tropez** | p. 258

CS1881

**Saint Tropez** | p. 258

CS1879

**Saint Tropez** | p. 258

CS1878

**Skin** | p. 268

CS1843

**Dalia** | p. 302

CS3454

**Dalia** | p. 302

CS3454

**Lazy** | p. 326

CS3373 360

**Mara** | p. 334

CS3456

**Oleandro** | p. 346

CS3452

**Coco** | p. 298

CS3395

**Fifties** | p. 308

CS3416

**Haven** | p. 312

CS3444

**Holly** | p. 318

CS3417

**Jill** | p. 322

CS3446

**Lazy** | p. 326

CS3373-W

**Lazy** | p. 326

CS3373-W

**Lazy** | p. 326

CS3373-C

**Lazy** | p. 326

CS3373-C

**Medea** | p. 342

CS3407

**Polse** | p. 352

CS3428

**Quadrotta** | p. 356

CS3409

**Rendez Vous** | p. 362

CS3418

**Rio** | p. 366

CS3445

**Shape** | p. 372

CS5083



Modello certificato Forest Stewardship Council® /Forest Stewardship Council® certified Model

COMPANY WITH MANAGEMENT SYSTEM CERTIFIED BY DNV ISO 9001-ISO 14001

Richiedi i prodotti certificati FSC® / Ask for FSC® certified products

Le pagine di questo catalogo propongono una serie di abbinamenti sedie, tavolo, complementi. Sono solo suggerimenti: sarà il gusto personale a determinare le scelte. I marchi e i segni distintivi riportati nel presente listino/catalogo sono validamente registrati e di esclusiva proprietà della Calligaris S.p.A.

Il rivenditore si obbliga a utilizzare correttamente il materiale promozionale e pubblicitario fornito dalla Calligaris S.p.A., senza, in alcun modo, ledere i marchi e i segni distintivi in esso riportati.

/The pages of this catalogue show only a number of furniture combinations. These are our suggestions: only your personal taste will determine your final choice. The distinctive marks and trademarks contained in this price list/catalogue are validly registered and are the sole property of Calligaris S.p.A. The retailer is obliged to

correctly use the promotional and advertising material supplied by Calligaris S.p.A., without damaging in any way the distinctive marks and trademarks contained therein.



Tessuto / Fabric



Sfoderabile /Removable



Seduta girevole a 360° /360° swivelling chair



Pelle /Leather



Sedia impilabile /Stackable chair



Seduta girevole con meccanismo di ritorno /Swivelling base features a self returning mechanism



Legno /Wood



Adatto ad uso esterno /For outdoor use



Base con meccanismo basculante /Base features a rocking mechanism



Plastica /Plastic



Regolabile in altezza /Adjustable height



Base con meccanismo basculante e girevole /Base features a rocking and swivelling mechanism

Abrey	024
Adèle	032
Aida	044
Anime	054
Annie	064
Atollo	074
Basil	078
Bess	088
Carmen	094
Claire	102
Cocoon	106
Etoile	116
Even Plus	122
Fifties	126
Foyer	138
Gala	154
Holly	162
Holly Fab	180
Igloo	190
Inès	198
Liberty	210
Love	216
Oleandro	224
Palm	242
Parisienne	246
Romy	254
Saint Tropez	258
Skin	268
Sophia	276
Sweel	280

Abrey è la classica seduta in legno reinterpretata all'insegna del comfort. Sedia, poltroncina e sgabello sono accomunati dall'ampio schienale che avvolge il sedile, sorretto dalle gambe posteriori. Un dettaglio che valorizza il retro delle sedute, ideali attorno al tavolo della stessa linea.

Abrey is the classic wooden seat reinterpreted in the name of comfort. Chair, armchair, and stool share the wide backrest that wraps around the seat, supported by the back legs. A detail that enhances the backs of the seats, ideal around the table of the same line.

Abrey



CS2040

CS2041

CS2042

design by Gabriele & Oscar Buratti

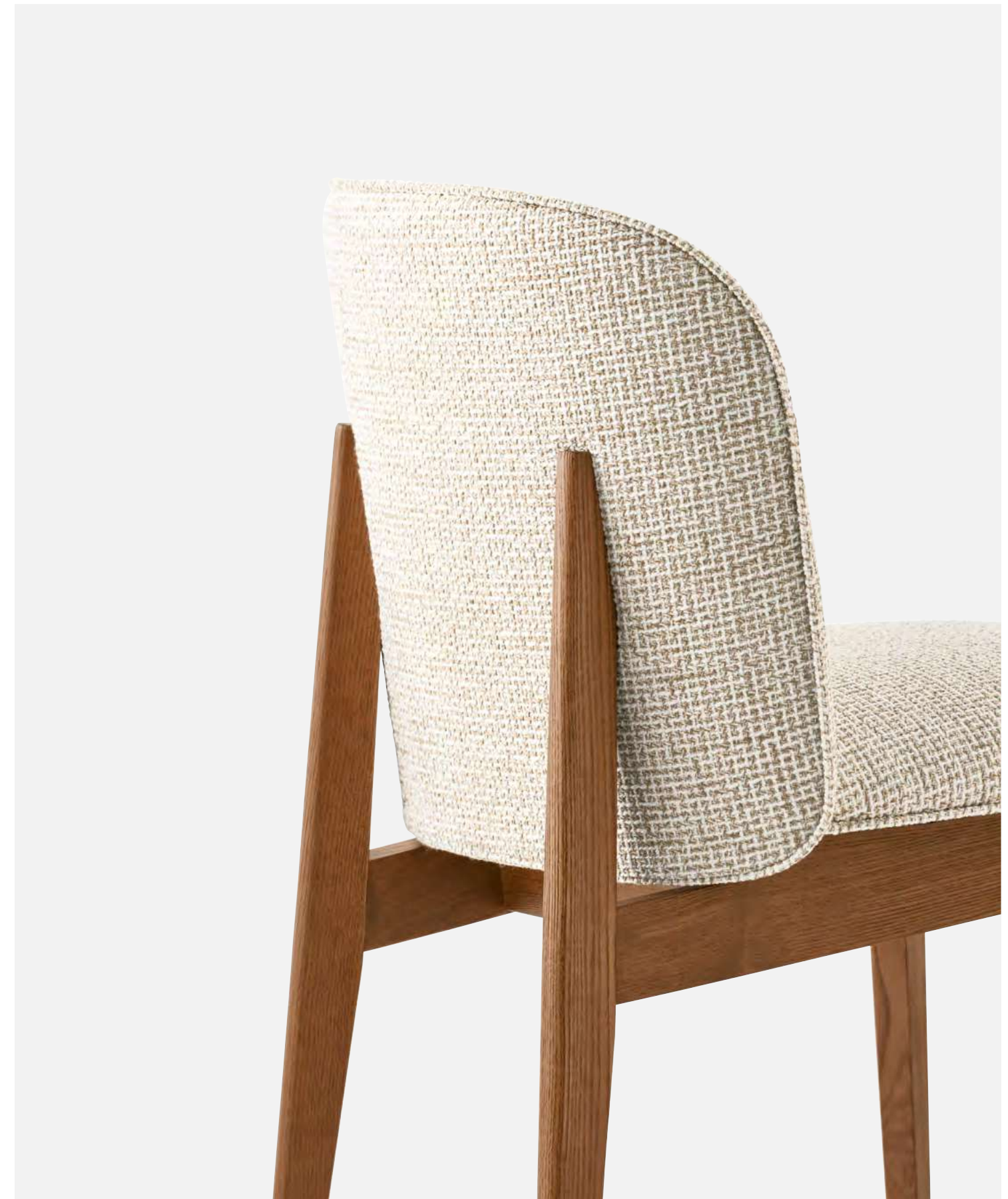





Abrey Connect Sgabello /Stool Tappeto /Rug CS2042-MTO P12 / SLU CS7255



Abrey Sgabello /Stool CS2042 P15L / SQN

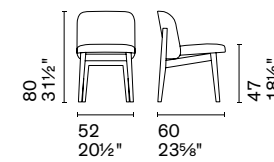

CS2040
CS2040-MTO

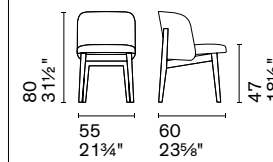

CS2041
CS2041-MTO

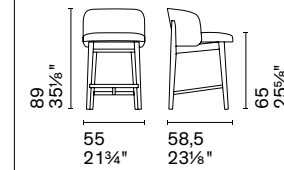

CS2042
CS2042-MTO

Nota Per le combinazioni disponibili consultare il listino prezzi. /**Note** Please check all available combinations in the price list.



Adèl è una collezione eterogenea e ricercata, che si è evoluta a partire da un'unica base in legno di frassino. Tra le diverse sedute disponibili, sempre confortevoli grazie all'uso di cinghie elastiche, spicca quella con schienale in legno curvato e paglia di Vienna, perfetta per gli ambienti più esclusivi.

Adèl is a heterogeneous and refined collection, evolved from a single ash wood base. Among the various available seats, always comfortable thanks to the use of elastic straps, the one that stands out is the one with a curved wooden and Vienna straw backrest, perfect for the most exclusive environments.

Adèl



CS2095

CS2202

CS2096

CS2099

CS2200





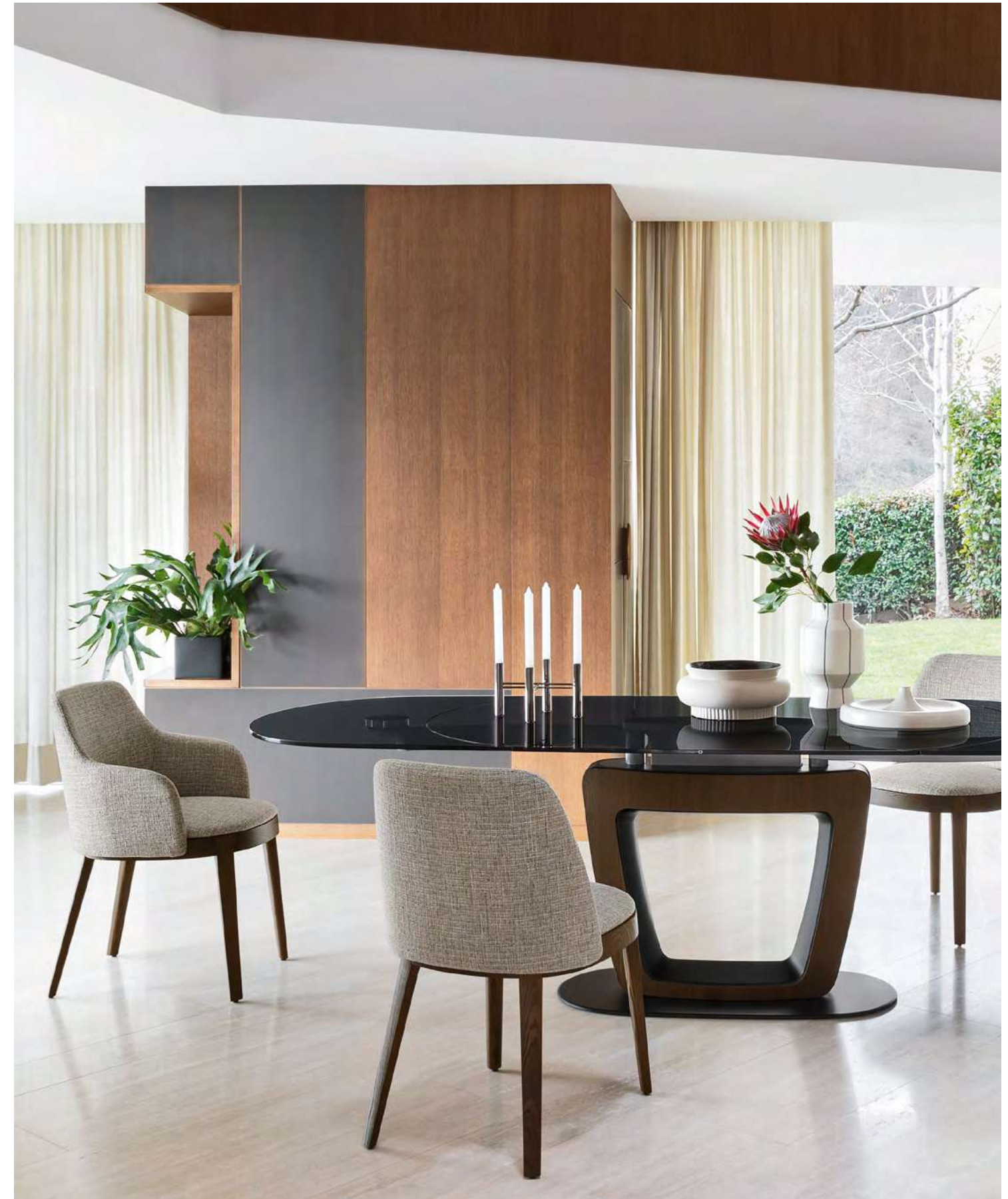





Adèl Sgabello /Stool CS2200-MTO P15L / SQS

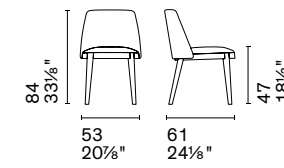

CS2095
CS2095-MTO

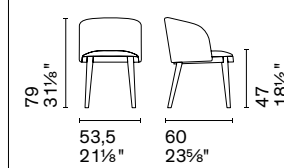

CS2096
CS2096-MTO

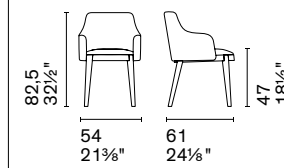

CS2099
CS2099-MTO

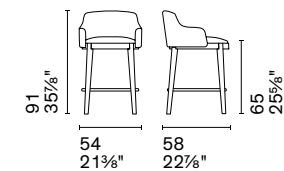

CS2200
CS2200-MTO

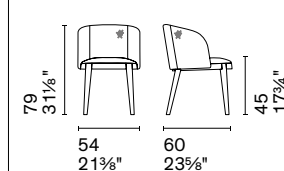

CS2202

Nota Per le combinazioni disponibili consultare il listino prezzi. /**Note** Please check all available combinations in the price list.



Aida è una delle collezioni più amate di Calligaris. In sedie e sgabelli, la modernità del metallo incontra un design dalle linee slanciate e dinamiche. L'estetica è minimal e a fare la differenza sono le finiture dei rivestimenti da scegliere tra metallo e tessuto, metallo e cuoio o tutto cuoio.

Aida is one of Calligaris' most beloved collections. In chairs and stools, the modernity of metal meets a design with slender and dynamic lines. The style is minimalist, and what makes the difference are the finishes of the coverings between metal and fabric, metal and leather, or all leather.

Aida



CS1484



CS1452



CS1452-A



CS1821



CS2017







Aida Sedia /Chair CS1452-AP176 / S95



Aida Sedia /Chair CS1452-AP15 / S0A



Aida

Sgabello /Stool

CS2017 P15 / S0B

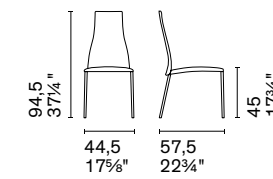

CS1484

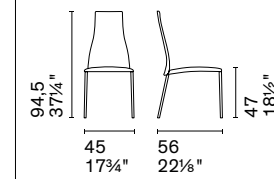
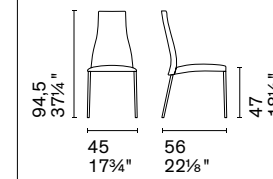
CS1452
CS1452-MTO

CS1452-A

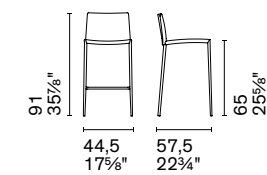

CS1821

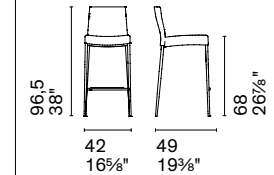
CS2017
CS2017-MTO

Nota Per le combinazioni disponibili consultare il listino prezzi. /**Note** Please check all available combinations in the price list.



Anime è una sedia dalle proporzioni equilibrate, che offre il massimo comfort grazie al sedile e allo schienale imbottiti. Le gambe in metallo le danno un tocco contemporaneo, rendendola adatta ad affiancare il tavolo all'interno di ambienti più classici o più moderni, sempre con eleganza.

Anime is a chair with balanced proportions, offering maximum comfort thanks to its padded seat and backrest. The metal legs give it a contemporary touch, making it suitable together with the table for both classic and modern environments, always with elegance.

Anime



CS2210

design by Archirivolto







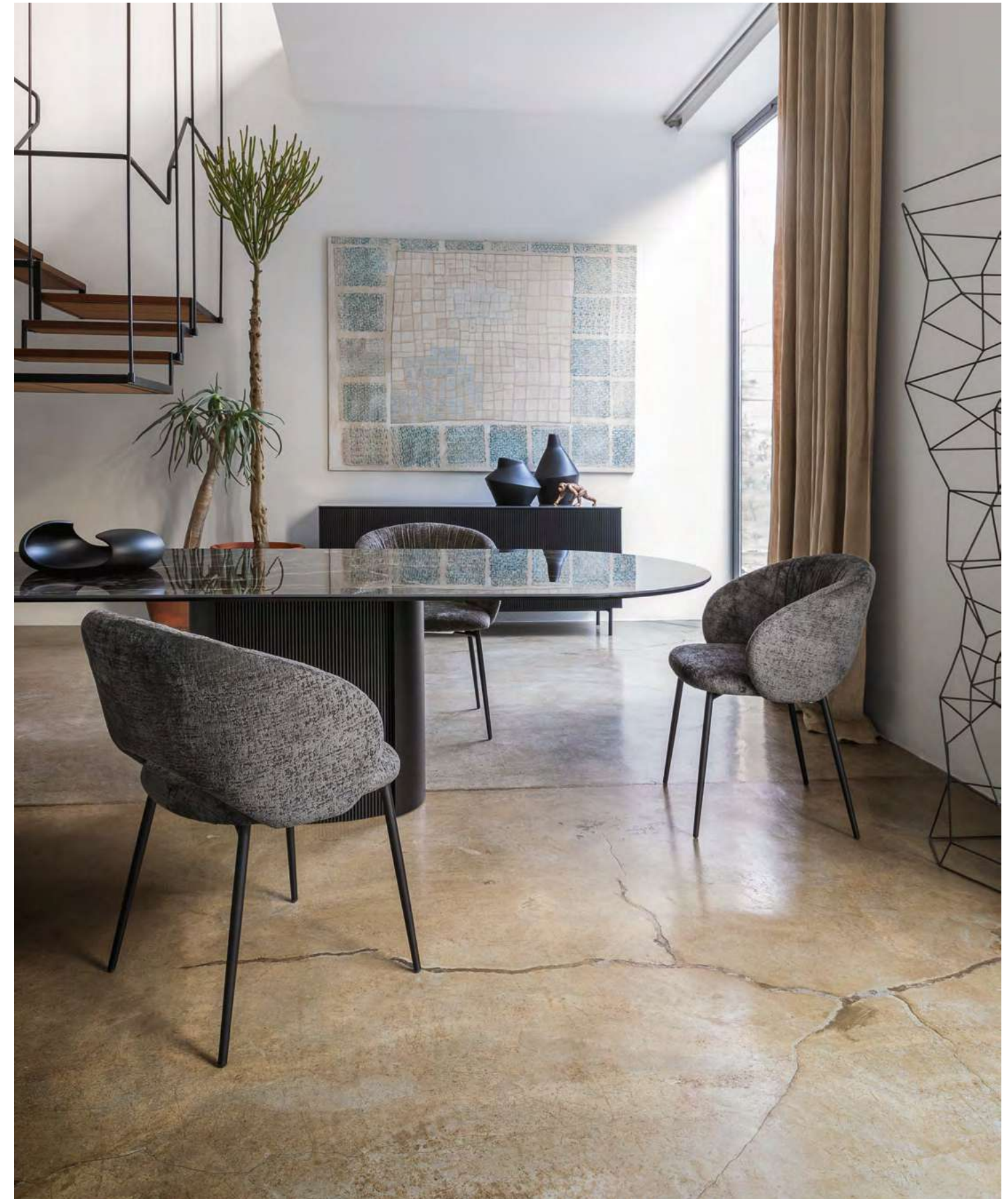

Anime
Yoroi

Sedia /Chair
Tavolo /Table

CS2210 P15 / T2L
CS4150-FE MTO P15-P15L / P30C



Anime Sedia /Chair CS2210 P15 / T2L

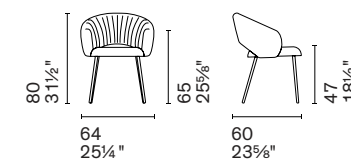

CS2210
CS2210-MTO

Nota Per le combinazioni disponibili consultare il listino prezzi. /**Note** Please check all available combinations in the price list.



Annie trova nella versatilità il suo punto di forza. La scocca è disponibile in due varianti, entrambe imbottite, con rivestimento teso o trapuntato. Numerose le basi disponibili, da scegliere a seconda dell'atmosfera ricercata: la sedia trova uno stile caldo e classico abbinata alle gambe in legno, contemporaneo con la base in metallo.

Annie finds its strength in versatility. The shell is available in two variants, both padded, with smooth or quilted covering. Many bases are available, to choose according to the desired atmosphere: the chair finds a warm and classic style with the wooden legs, contemporary with the metal base.

Annie



CS1809

CS1852

CS1846

CS1848

CS1847







Annie
Cartesio
Sky

Sedia /Chair
Tavolo /Table
Tappeto /Rug

CS1847 P15 / S0F
CS4111-R MTO P15 / P321
CS7192



Annie Sedia /Chair CS1809-MTO P201 / SLT



Annie Sedia /Chair CS1809-MTO P201 / SQ1



Annie Sedia /Chair CS1852-MTO P15 / SLR



Annie Sedia /Chair CS1852 P15 / SQ4

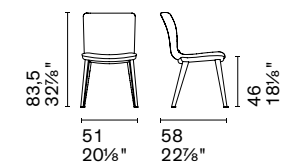

CS1809
CS1809-MTO

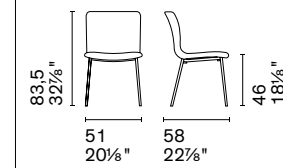

CS1852
CS1852-MTO

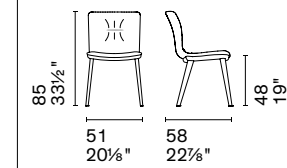

CS1846
CS1846-MTO

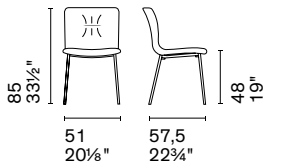

CS1848
CS1848-MTO

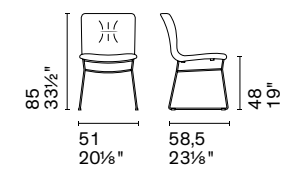

CS1847
CS1847-MTO

Nota Per le combinazioni disponibili consultare il listino prezzi. /**Note** Please check all available combinations in the price list.



La collezione Atollo si ispira alle isole coralline disposte ad anello, di cui richiama le linee curve e rotonde. A caratterizzarla è la struttura in tondino di metallo, che sorregge una seduta imbottita e trapuntata a losanghe. E se gli sgabelli trovano la loro collocazione ideale nella zona giorno, la panca può diventare un ricercato complemento nella zona notte.

The Atollo collection is inspired by the coral islands arranged in a ring, recalling their curved and round lines. It is characterized by a metal rod frame that supports a padded and diamond-quilted seat. And if the stools find their ideal location in the day area, the bench can become a refined complement in the night area.

Atollo



CS1876



CS5104



CS5105

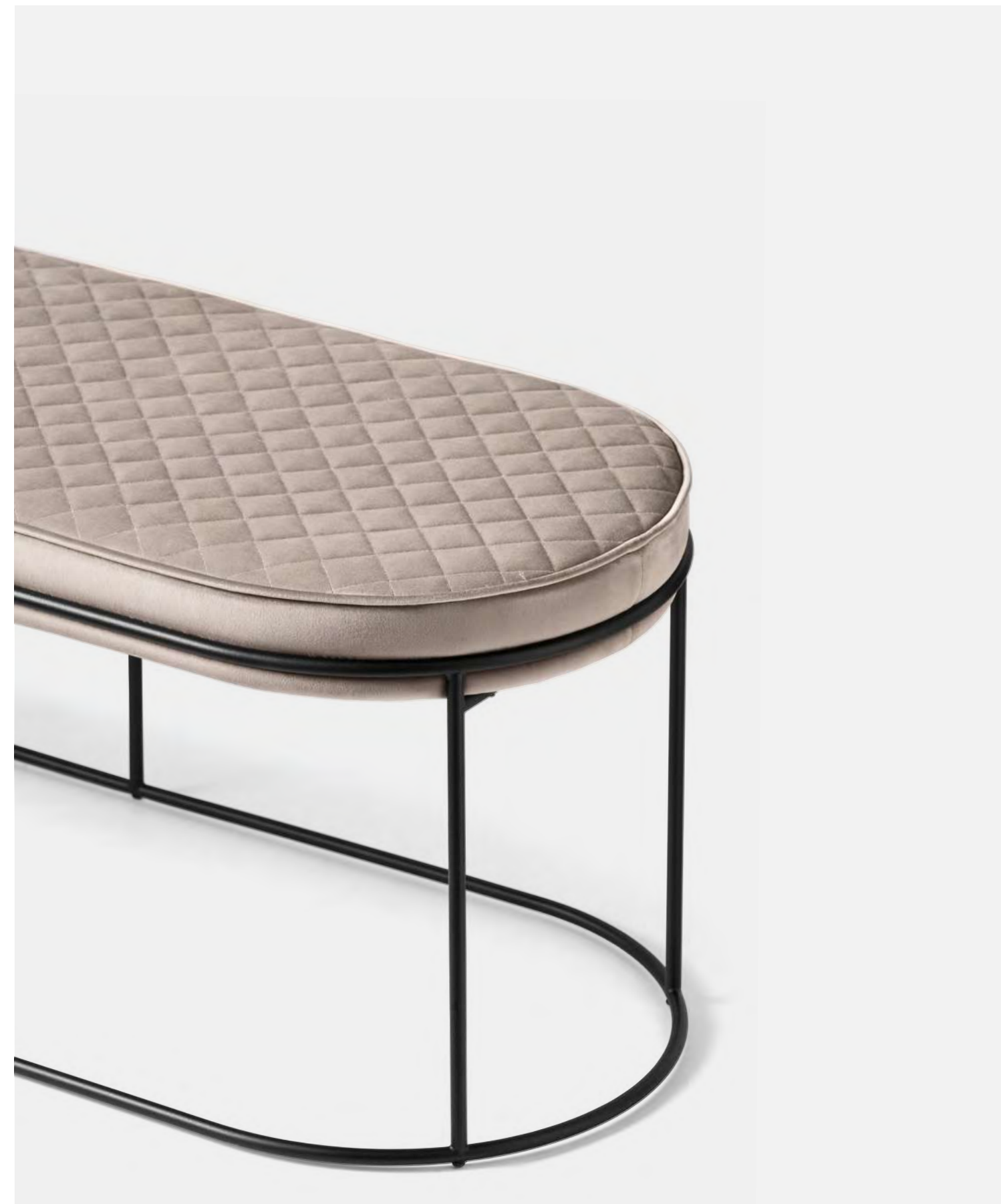

Atollo Sgabello /Stool CS1876 P175 / S0F

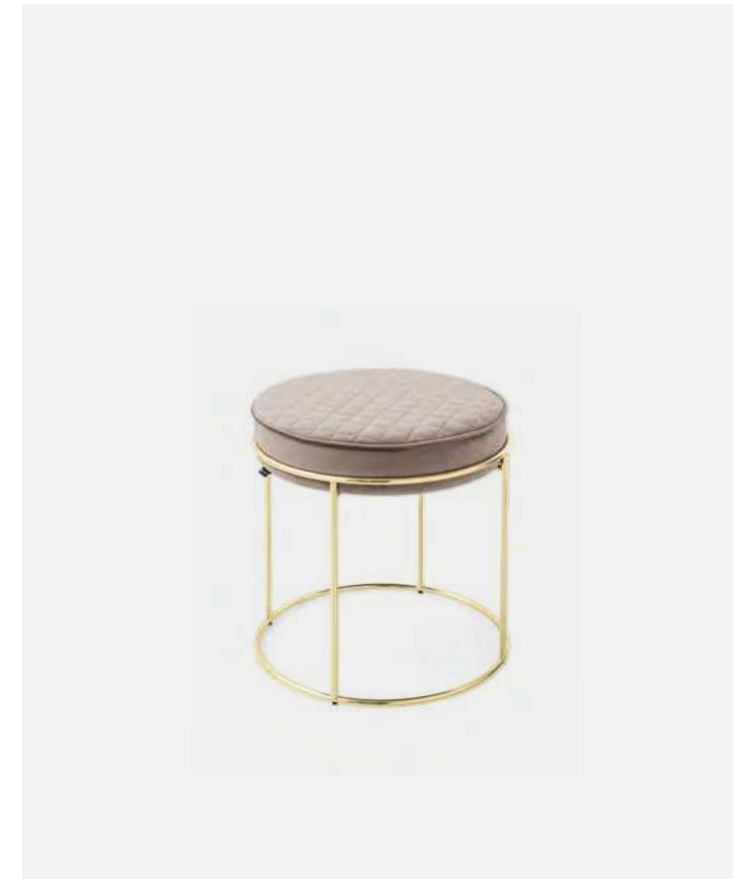

Atollo Pouf /Ottoman CS5104 P175 / S0F



Atollo Panca /Bench CS5105 P175 / S0F

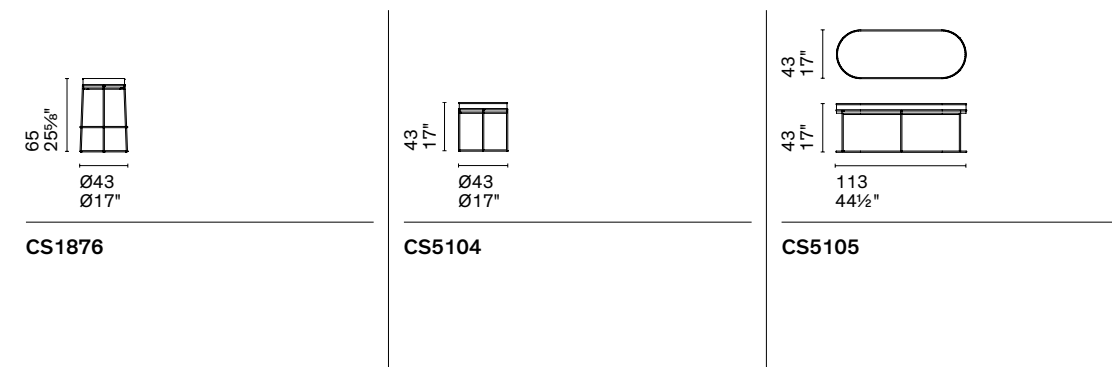

Nota Per le combinazioni disponibili consultare il listino prezzi. /**Note** Please check all available combinations in the price list.



Basil è una collezione di sedute molto ampia, dall'estetica multiforme. Punto di partenza è la scocca ispirata a una foglia di basilico, dove la nervatura centrale è un tema sia strutturale sia decorativo. In polipropilene o rivestita in cuoio, si abbina a diverse basi in legno o metallo, anche con ruote, e si declina nella versione sgabello.

Basil is a very extensive collection of seats with a multifaceted look. The starting point is the shell inspired by a basil leaf, where the central vein is both a structural and decorative theme. In polypropylene or covered in leather, it combines with several wooden or metal bases, also with wheels, and is available in stool version.

Basil



CS1348

CS1359

CS1856

CS1857



CS1495

CS1354

CS1356

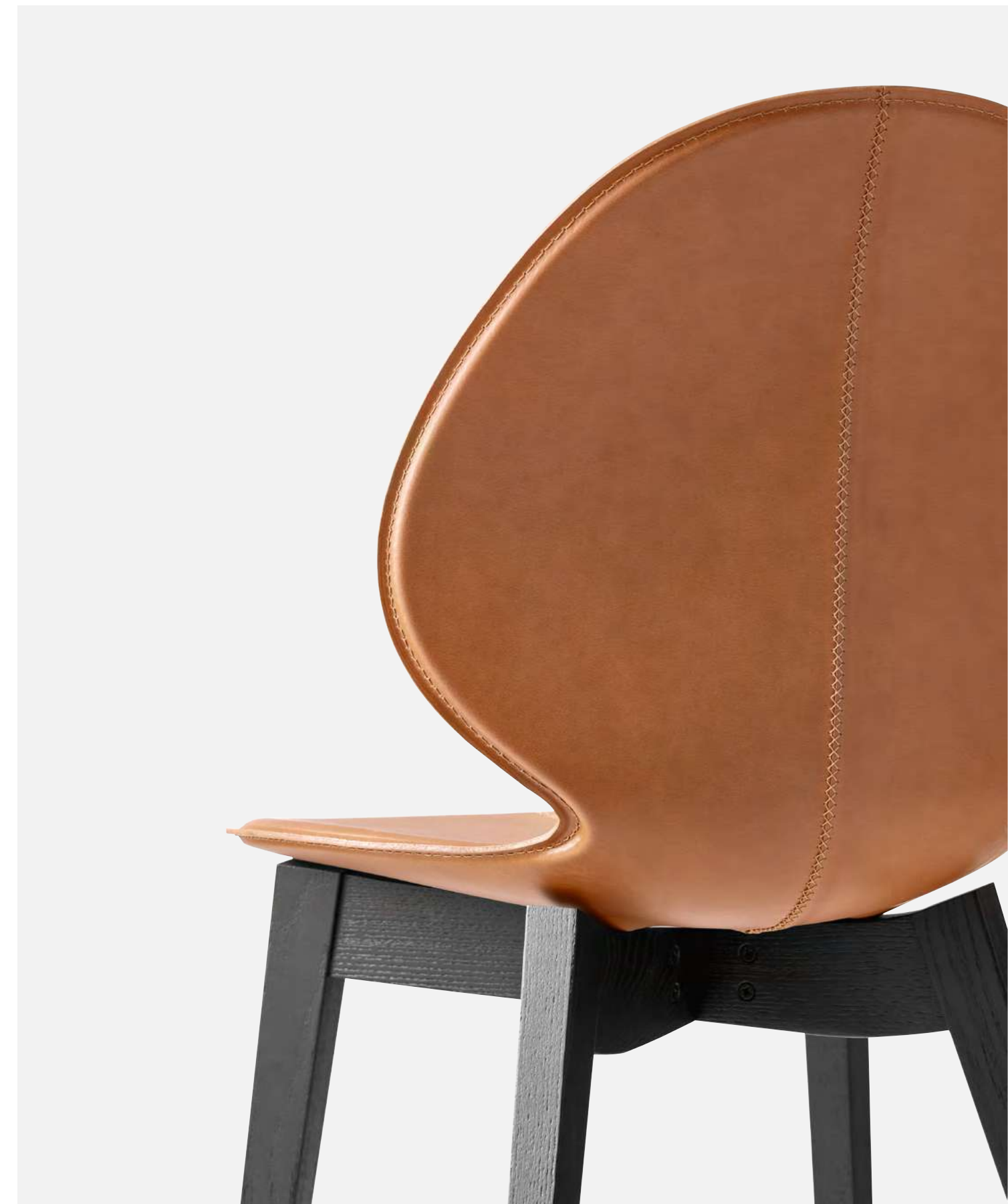



Basil Sgabello /Stool CS1495 P02 / 315





Basil Sgabello /Stool CS1354 P15 /P16

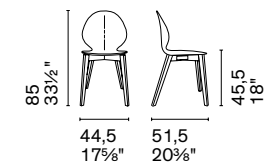

CS1348

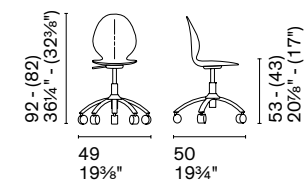

CS1857

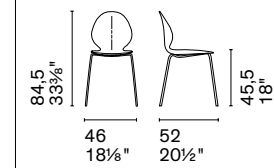

CS1359

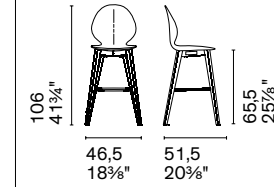

CS1495

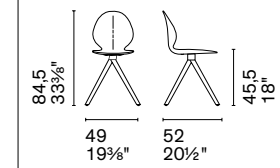

CS1856 180

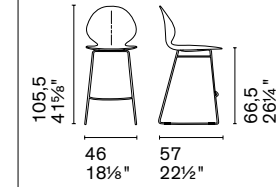

CS1354

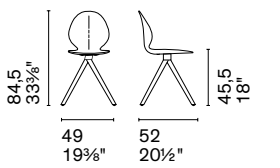

CS1856 360

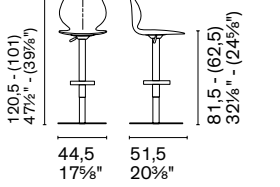

CS1356



Nota Per le combinazioni disponibili consultare il listino prezzi. /**Note** Please check all available combinations in the price list.



Sedia classica con gambe in legno massello, seduta imbottita e schienale alto, Bess è pensata per i luoghi della convivialità. La cura progettuale si rivela nella continuità visiva della linea che unisce gambe posteriori e schienale, ma anche nell'attenzione al comfort, reso speciale dalle cinghie elastiche.

A classic chair with solid wood legs, padded seat, and tall backrest, Bess is designed for convivial spaces. The design care is evident in the visual continuity of the line that joins the back legs and backrest, but also in the attention to comfort, made special by the elastic straps.

Bess



CS1294

CS1463

CS1445-MTO





Bess
Omnia

Sedia /Chair
Tavolo /Table

CS1294 P12 / D04
CS4058-R P12 / P321



Bess Sgabello /Stool CS1445-MTO P132 /D04

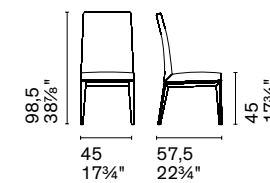

CS1294
CS1294-MTO

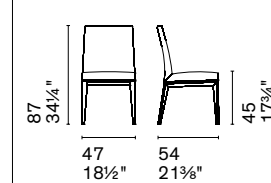

CS1463
CS1463-MTO

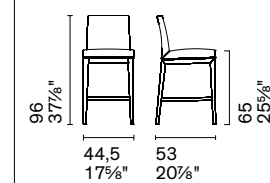

CS1445-MTO

Nota Per le combinazioni disponibili consultare il listino prezzi. /**Note** Please check all available combinations in the price list.



A caratterizzare la collezione Carmen sono linee slanciate ed essenziali. Le gambe in metallo sono sottili, così come lo spessore di seduta e schienale, resi però confortevoli dall'imbottitura con cuscino fisso che crea un'interessante piega sul retro. Carmen è disponibile anche in versione sgabello con poggiatesta.

The Carmen collection is characterized by slender and minimalist lines. The metal legs are thin, as is the thickness of the seat and backrest, made comfortable by the padding with a fixed cushion that creates an interesting fold at the back. Carmen is also available as a stool with footrest.

Carmen



CS2052

CS2209

CS2217

design by Gino Carollo







Carmen Sgabello / Stool CS2217 P15 / SLR



Carmen Sgabello / Stool CS2217 P15 / SLR

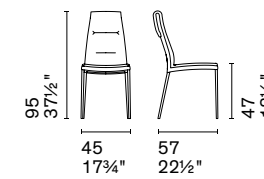

CS2052
CS2052-MTO

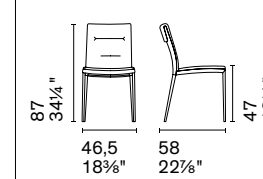

CS2209
CS2209-MTO

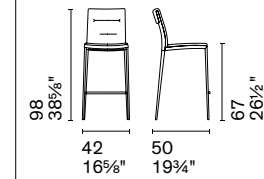

CS2217
CS2217-MTO

Nota Per le combinazioni disponibili consultare il listino prezzi. / **Note** Please check all available combinations in the price list.



Con Claire, Calligaris reinterpreta la sedia in legno di tradizione nordica. Quattro robuste gambe in legno massello di frassino sorreggono l'ampio sedile curvato e lo schienale avvolgente, entrambi imbottiti e rivestiti. Solida e confortevole, Claire è una sedia che supera il passare del tempo, a suo agio in ambienti domestici dagli stili diversi.

With Claire, Calligaris reinterprets the traditional Nordic wooden chair. Four robust legs in solid ash wood support the wide curved seat and the enveloping backrest, both padded and upholstered. Solid and comfortable, Claire is a chair that stands the test of time, at ease in domestic environments with different styles.

Claire



CS1443

design by Orlandini design



Claire
OmniaSedia / Chair
Tavolo / TableCS1443 P12 / S0B
CS4058 R P12 / P18C

Claire

Sedia / Chair

CS1443 P12 / A03

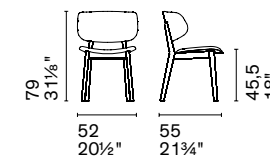

CS1443

Nota Per le combinazioni disponibili consultare il listino prezzi. / **Note** Please check all available combinations in the price list.



La sedia Cocoon aggiorna le forme delle poltroncine anni Sessanta attraverso linee attuali e spessori generosi. Alle diverse basi disponibili si possono abbinare la scocca slim, più asciutta, o la soft, dall'estetica più soffice, entrambe comode e accoglienti. Cocoon è disponibile anche nelle ricercate versioni bicolor e bimateriale con profilo cordonato.

The Cocoon chair updates the shapes of 1960s armchairs through contemporary lines and generous thicknesses. The various available bases can be combined with the slim shell, more streamlined, or the soft one, with a softer look, both comfortable and welcoming. Cocoon is also available in the refined two-tone and two-material versions with corded profile.

Cocoon



CS2074



CS2076



CS2077



CS2078



CS2083



CS2084



CS2085



CS2086

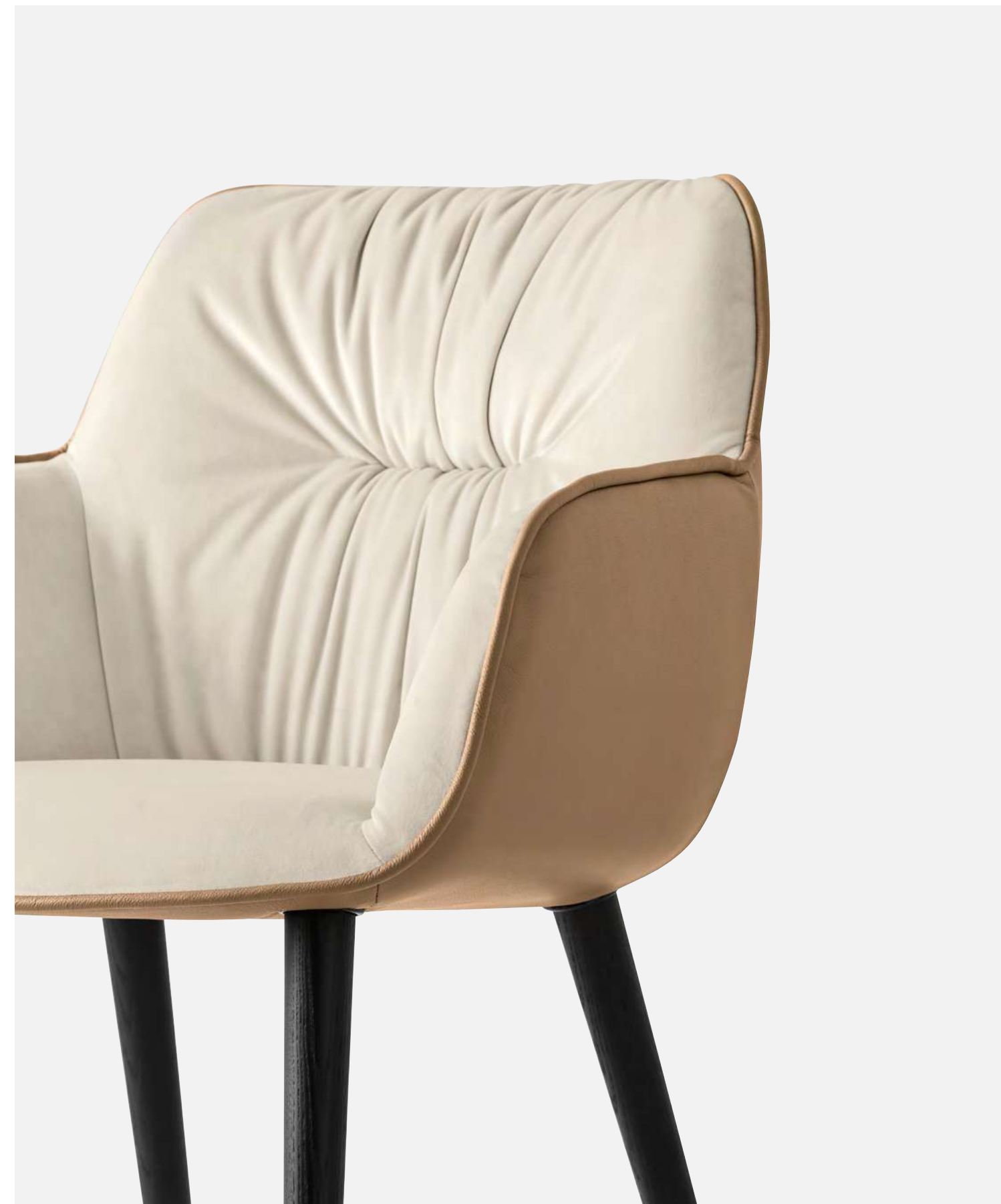



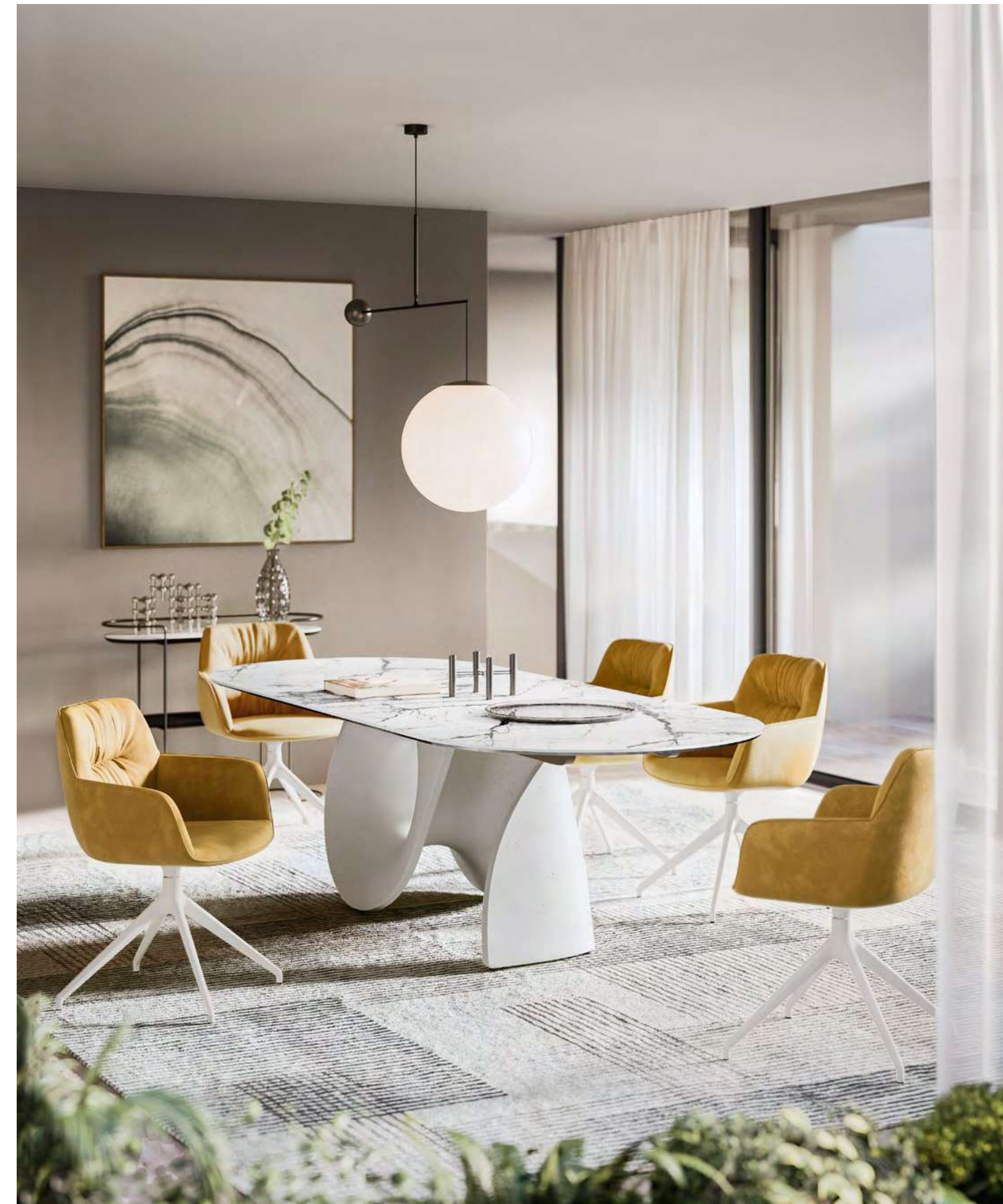



Cocoon Sedia / Chair CS2074-MTO P15L / SQR

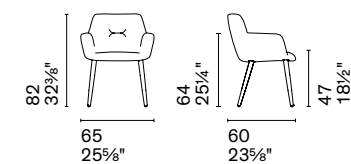

CS2074-MTO

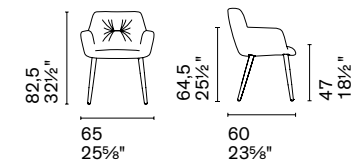

CS2083
CS2083-BI
CS2083-MTO

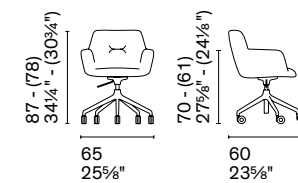

CS2078-MTO

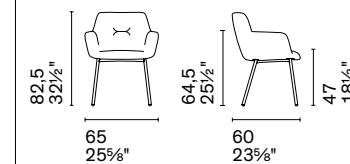

CS2076-MTO

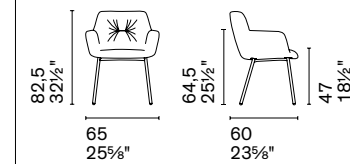

CS2084
CS2084-BI
CS2084-MTO

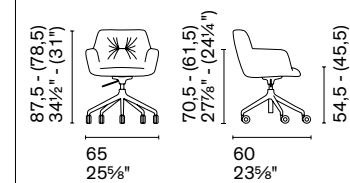

CS2086
CS2086-BI
CS2086-MTO

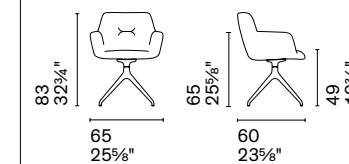

CS2077-MTO 180

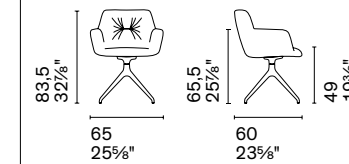

CS2085 180
CS2085-BI 180
CS2085-MTO 180

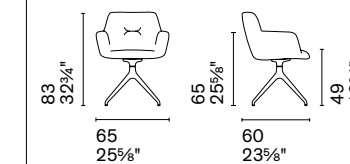

CS2077-MTO 360

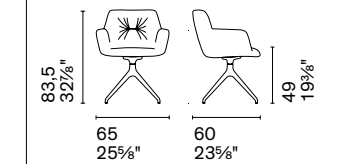

CS2085 360
CS2085-BI 360
CS2085-MTO 360



Nota Per le combinazioni disponibili consultare il listino prezzi. /Note Please check all available combinations in the price list.



La collezione Etoile è pensata per ambienti domestici dal gusto classico. La scocca della sedia, da abbinare alla base in legno o metallo, è caratterizzata dallo schienale alto e sottile in poliuretano morbido, un materiale che assicura un comfort duraturo nel tempo. Lo stesso profilo si riconosce nello sgabello.

The Etoile collection is designed for domestic environments with a classic taste. The chair shell, to be combined with a wooden or metal base, is characterized by a tall and thin backrest in soft polyurethane, a material that ensures long-lasting comfort. The same profile can be recognized in the stool.

Etoile



CS1423

CS1424

design by Studio 28





Etoile
Sunshine

Sedia / Chair
Tavolo / Table

CS1423-MTO P132 / SLU
CS4128-S P15 / P33L / P18C



Etoile Sedia / Chair CS1423 P201 / A03

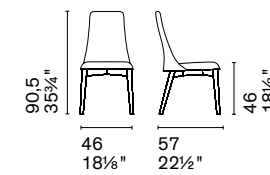

CS1423
CS1423-MTO

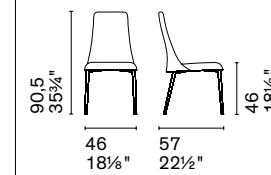

CS1424
CS1424-MTO

Nota Per le combinazioni disponibili consultare il listino prezzi. / **Note** Please check all available combinations in the price list.



Per le linee squadrate e la predominanza del metallo, Even Plus si esprime al meglio in ambienti moderni. La struttura incassata a filo dello schienale e il poggiatesta sono al contempo funzionali e visivamente accattivanti. Lo sgabello, girevole e regolabile in altezza con pistone a gas, si completa con una comoda seduta imbottita.

With its square lines and the predominance of metal, Even Plus best expresses itself in modern environments. The recessed structure flush with the backrest and the footrest are both functional and visually appealing. The stool, swivel and height-adjustable with a gas piston, is completed by a comfortable padded seat.

Even Plus



CS1394



Even Plus Sgabello / Stool CS1394 P77 / D04



Even Plus Sgabello / Stool CS1394 P77 / 705

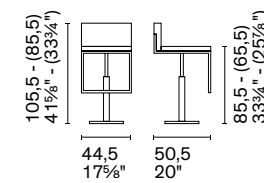

CS1394

Nota Per le combinazioni disponibili consultare il listino prezzi. / **Note** Please check all available combinations in the price list.



Fifties è una collezione dal sapore vintage che celebra l'estetica anni Cinquanta, tra gambe in metallo e linee morbide e curve. Ampia, e in continuo aggiornamento, la gamma di finiture, che ne trasforma lo stile in base all'effetto ricercato. La sedia Fifties è ideale per affiancare il tavolo da pranzo e perfetta da abbinare all'omonima poltrona.

Fifties is a collection with a vintage flavour that celebrates the style of the 1950s, with metal legs and soft, curved lines. The range of finishes, extensive and constantly updated, transforms its style according to the desired effect. The Fifties chair is ideal for accompanying the dining table and perfect with the armchair of the same name.

Fifties



CS1854

CS1854-A MTO

CS1864

CS1864-A MTO

CS2006

design by Busetti Garuti Redaelli







Fifties Sgabello / Stool CS2006 P15 / L10





Fifties
Cartesio

Sedia / Chair
Tavolo / Table

CS1854 P175 / S0F
CS4092-FD P94 / P4C

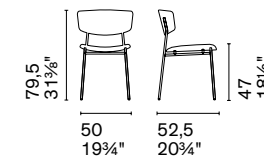

CS1854
CS1854-MTO

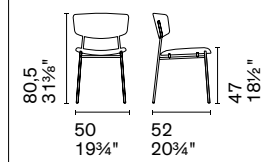

CS1854-A MTO

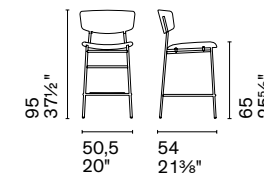

CS1864
CS1864-MTO

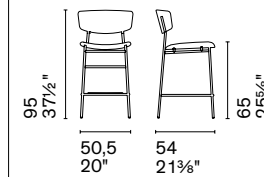

CS1864-A MTO

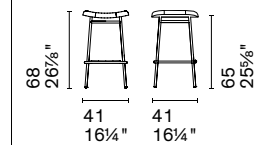

CS2006
CS2006-MTO

Nota Per le combinazioni disponibili consultare il listino prezzi. / **Note** Please check all available combinations in the price list.



Best seller di Calligaris, Foyer è una sedia imbottita che per volumi e comfort somiglia a una poltroncina. Merito dello schienale avvolgente e del morbido sedile con struttura a cinghie elastiche. Oltre alle diverse basi, sono disponibili quattro tipologie di scocca, anche con braccioli e apertura posteriore per maneggiare più facilmente la sedia.

Calligaris' best seller, Foyer is a padded chair that resembles an armchair in terms of volume and comfort, thanks to the enveloping backrest and the soft seat with elastic straps structure. In addition to the several bases, four types of shell are available, also with armrests and rear opening for easier handling.

Foyer



CS1888

CS1896

CS1889

CS1898



CS1899

CS1895

CS2000

CS1897

CS2072













Foyer Sgabello / Stool CS2072 P12 / SLX



Foyer
Sunshine
Chinese

Sedia / Chair
Tavolo / Table
Tappeto / Rug

CS1889 P15L / S2N
CS4128-R P15 / P29L / P14C
CS7209



Foyer Sedia / Chair CS1888 P15L / S2P



Foyer Sedia / Chair CS1899-MTO P15L / S2P



Foyer Sedia / Chair CS1896 P15 / S2P



Foyer Sedia / Chair CS1895 P29L / S0F

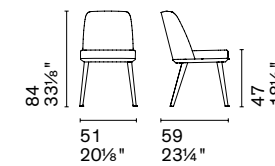

CS1888
CS1888-MTO

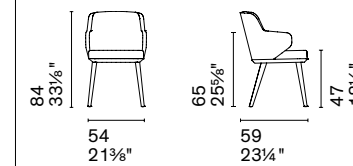

CS1889
CS1889-MTO

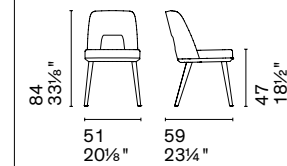

CS1899
CS1899-MTO

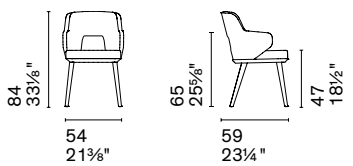

CS2000
CS2000-MTO

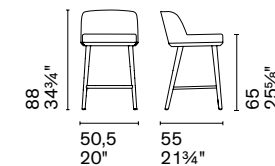

CS2072
CS2072-MTO

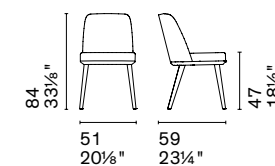

CS1896
CS1896-MTO

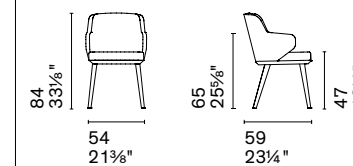

CS1898
CS1898-MTO

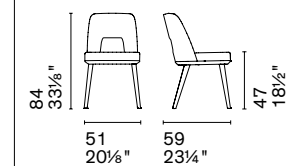

CS1895
CS1895-MTO

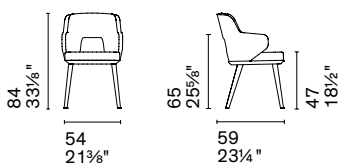

CS1897
CS1897-MTO

Nota Per le combinazioni disponibili consultare il listino prezzi. /Note Please check all available combinations in the price list.



Gala è una linea di sedie e sgabelli dallo stile rétro. La seduta, imbottita e confortevole, sembra ancora più voluminosa a contrasto con la struttura sottile in metallo. Camaleontiche le finiture, che ne trasformano l'estetica in base ai gusti e all'atmosfera desiderata.

Gala is a line of chairs and stools with a retro style. The padded and comfortable seat seems even more voluminous in contrast to the thin metal structure. The finishes are chameleonic, transforming its style according to your taste and desired atmosphere.

Gala



CS1866

CS1867

CS1868-MTO

CS1870-MTO







Gala Sgabello / Stool CS1868-MTO P175 / SOL



Gala Sgabello / Stool CS1870-MTO P15 / S0F

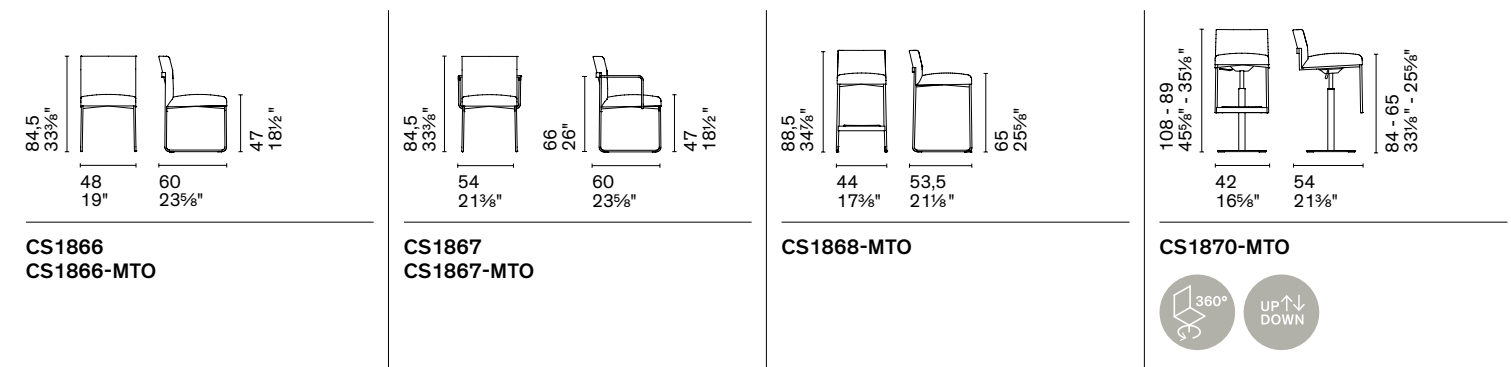

Nota Per le combinazioni disponibili consultare il listino prezzi. / **Note** Please check all available combinations in the price list.



Si ispira al design anni Cinquanta una delle collezioni più amate di Calligaris, Holly. Il comfort eccezionale si deve alle dimensioni generose del sedile e dello schienale, che continua fino a diventare un bracciolo. Diverse le tipologie di base tra cui scegliere, per una seduta che copre tutte le esigenze domestiche, dalla sala da pranzo all'home office.

One of Calligaris' most beloved collections, Holly, is inspired by the design of the 1950s. The exceptional comfort is due to the generous dimensions of the seat and backrest, which extends long enough to become armrest. Many types of bases are available, for a seat that meets all domestic needs, from the dining room to the home office.

Holly



CS2080

CS2037

CS2056

CS2057

CS2038





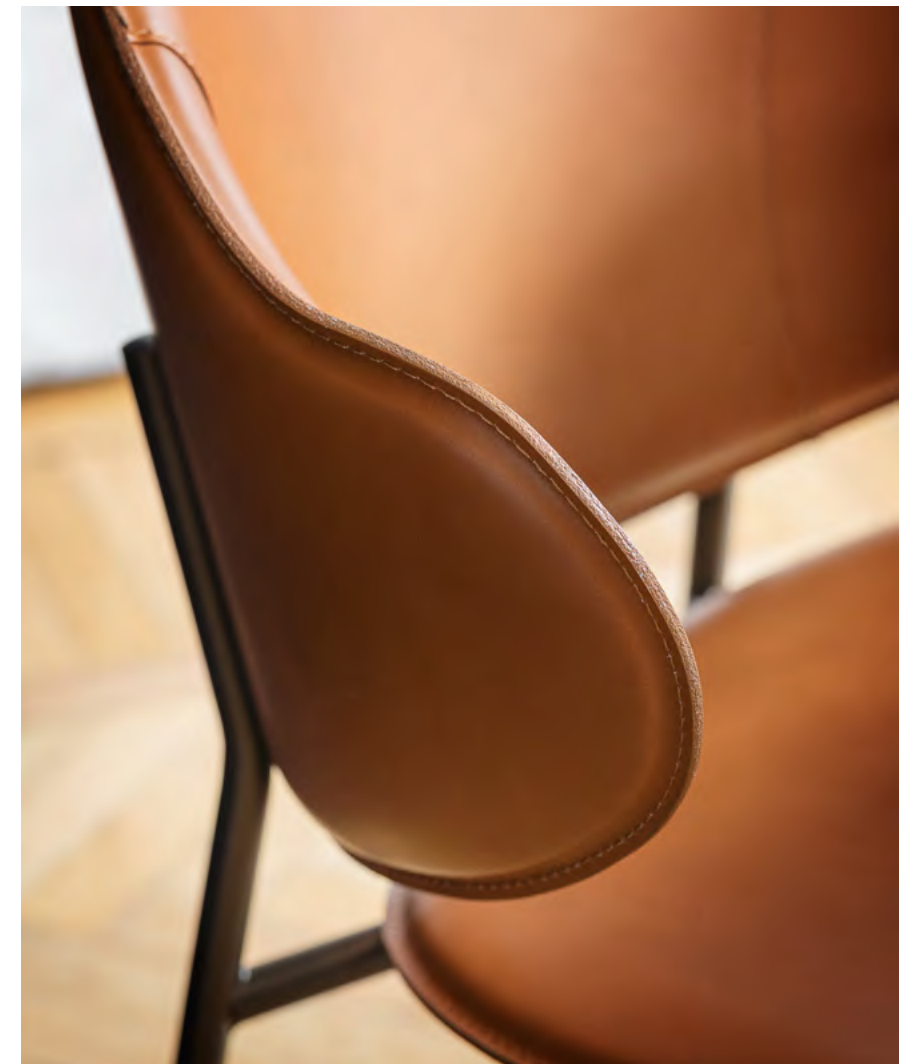











Holly
Madame
Terrazzo

Sedia / Chair
Scrivania / Desk
Tappeto / Rug

CS2058 P15 / S0H
CS4135 P15-P175 / P67W
CS7208

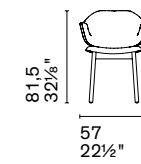

CS2080
CS2080-MTO

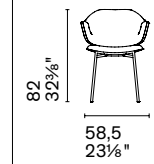
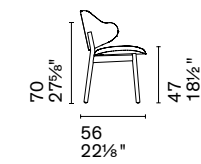

CS2037
CS2037-MTO

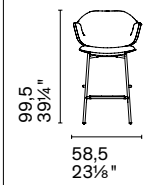

CS2038
CS2038-MTO

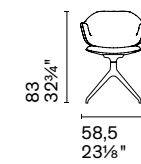

CS2056 180

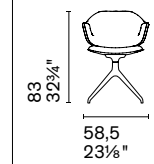
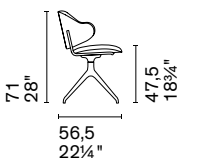

CS2056 360

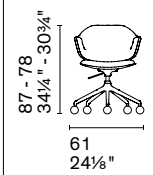

CS2057



Nota Per le combinazioni disponibili consultare il listino prezzi. /Note Please check all available combinations in the price list.



Holly Fab è l'evoluzione della sedia Holly, dalla quale si distingue per lo schienale ancora più comodo e avvolgente, che abbraccia il sedile. A sostenere la seduta è una solida base in legno massello, oppure quattro sottili gambe in metallo che ne slanciano la linea.

Holly Fab is the evolution of the Holly chair, distinguished by an even more comfortable and enveloping backrest that embraces the seat. Supporting the seat is a strong base in solid wood, or four slender metal legs that slim down its line.

Holly Fab



CS2206

CS2212

design by Busetti Garuti Redaelli





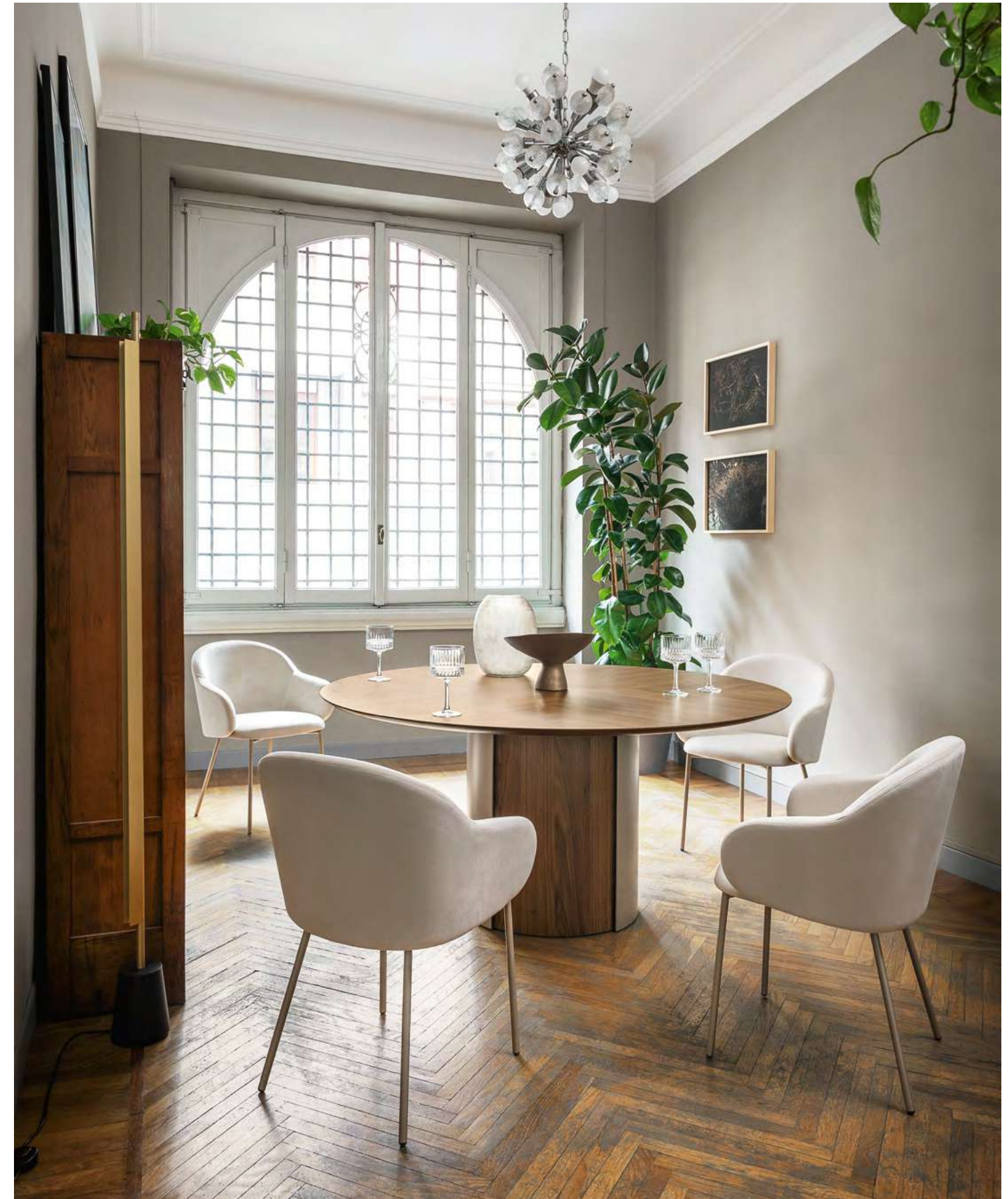



Holly Fab Sedia / Chair CS2206 P201 / SLV



Holly Fab Sedia / Chair CS2206 P201 / SLV

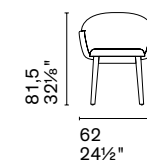

CS2206
CS2206-MTO

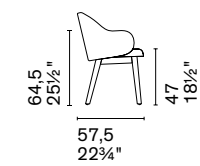

CS2212
CS2212-MTO

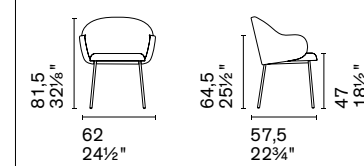

Nota Per le combinazioni disponibili consultare il listino prezzi. / **Note** Please check all available combinations in the price list.



Più comoda di una sedia, più compatta di una poltroncina: Igloo è una seduta multibase ideale da accostare al tavolo da pranzo o alla scrivania. La scocca, confortevole e avvolgente, presenta due possibilità di rivestimento: con imbottitura trapuntata, dall'estetica più morbida, o con imbottitura slim, dalle linee più snelle.

More comfortable than a chair, more compact than an armchair: Igloo is a multi-base seat ideal for pairing with a dining table or desk. The comfortable and enveloping shell offers two covering options: quilted padding, with a softer look, or slim padding, with slimmer lines.

Igloo



CS1810

CS1835

CS1838-MTO



CS1841

CS1874

CS1873-MTO

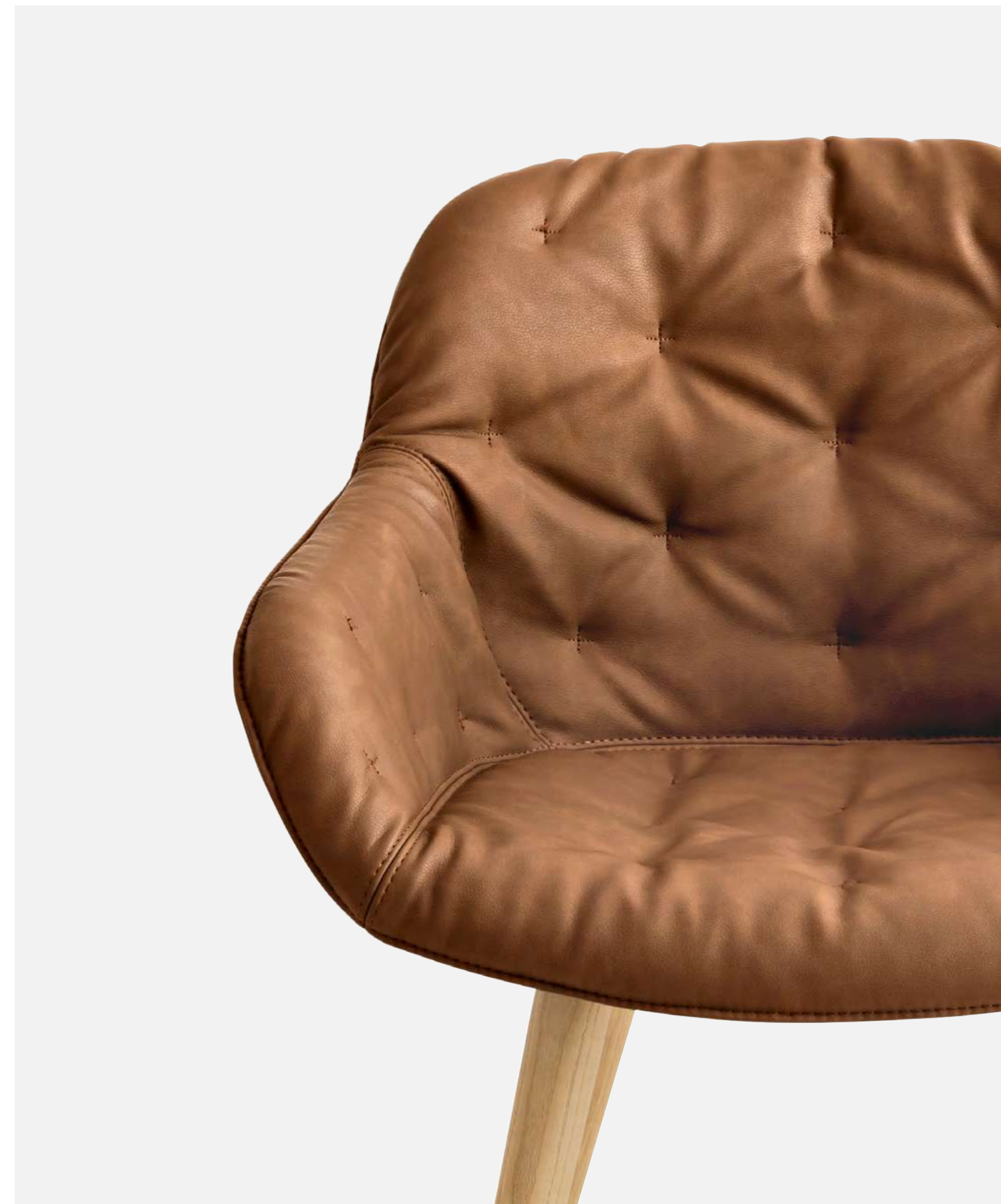



Igloo
Connect

Sedia / Chair
Tappeto / Rug

CS1835-MTO P94 / S8P
CS7255



Igloo
Elson
Roche

Sedia / Chair
Tavolo / Table
Tappeto / Rug

CS1810 P94 / SQ5
CS4137-E P94-P29L / P9C
CS7258



Igloo
Cartesio

Sedia / Chair
Tavolo / Table

CS1841 P94 / S0L
CS4111-S P94 / P9C

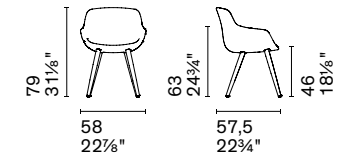

CS1810
CS1810-MTO

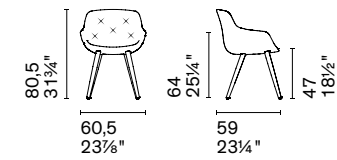

CS1841
CS1841-MTO

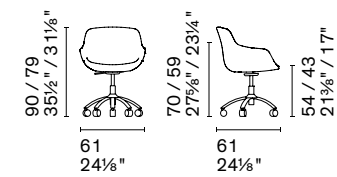

CS1838-MTO

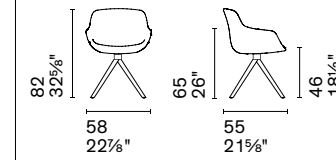

CS1835-MTO 180

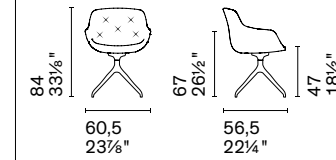

CS1874-MTO 180

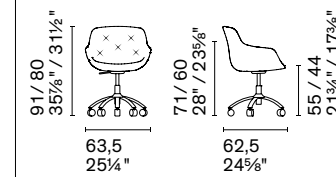

CS1873-MTO

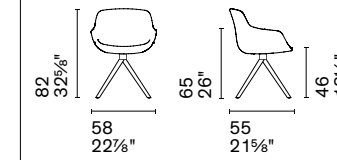

CS1835-MTO 360

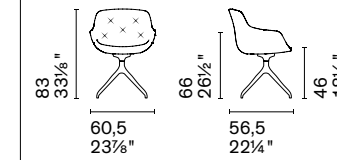

CS1874-MTO 360



Nota Per le combinazioni disponibili consultare il listino prezzi. /Note Please check all available combinations in the price list.



Con le sue forme morbide e aggraziate, Inès richiama le sedute anni Cinquanta. Sedile e schienale dal profilo tondeggiante acquistano lo stile desiderato in base alla struttura e alle finiture scelte – sofisticato in metallo dorato, industrial in metallo nero, caldo e domestico nella versione con gambe in legno.

With its soft and graceful shapes, Inès recalls the chairs of the 1950s. The seat and backrest with rounded profile acquire the desired style depending on the chosen structure and finishes – sophisticated in golden metal, industrial in black metal, warm and domestic in the version with wooden legs.

Inès



CS2079

CS2004

CS2022

design by Busetti Garuti Redaelli











Inès Sgabello / Stool CS2022 P15 / S0A



Inès Sgabello / Stool CS2022 P15 / S0A

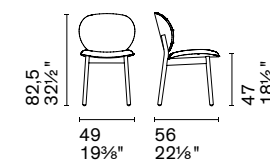

CS2079
CS2079-MTO

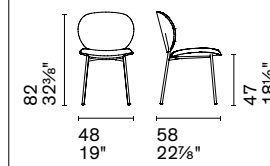

CS2004
CS2004-MTO

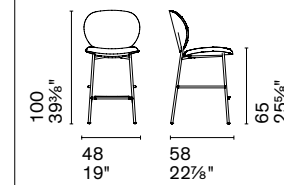

CS2022
CS2022-MTO

Nota Per le combinazioni disponibili consultare il listino prezzi. / **Note** Please check all available combinations in the price list.



Le sedie dei caffè viennesi di metà Ottocento trovano nuova espressività in Liberty, una seduta leggera, resistente e impilabile disponibile in due versioni, con o senza braccioli. Adatta anche all'uso outdoor e costantemente aggiornata nei colori di tendenza, è un'icona accessibile e sempre attuale.

The chairs of Viennese cafes of the mid-19th century find new expression in Liberty, a light, resistant, and stackable seat available in two versions, with or without armrests. Also suitable for outdoor use and constantly updated with trendy colours, it is an accessible and always-relevant icon.

Liberty



CS1883

CS1884





Liberty
Balance

Sedia / Chair
Tavolo / Table

CS1884 P28P
CS4121-FD P15 / P15



Liberty Sedia / Chair CS1883 P28P

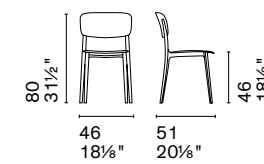

CS1883

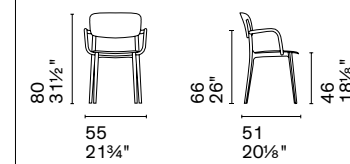

CS1884

Nota Per le combinazioni disponibili consultare il listino prezzi. / **Note** Please check all available combinations in the price list.



Love è una sedia imbottita dalle forme morbide e dal sapore vintage. Il dettaglio che accomuna le due versioni, semplice e trapuntata, è il prolungamento a T delle gambe metalliche, che sembrano supportare lo schienale. La ricca imbottitura e la scelta di finiture di pregio come il velluto fanno di Love una sedia preziosa.

Love is a padded chair with soft shapes and a vintage flavour. The detail that unites the two versions, simple and quilted, is the T-shaped extension of the metal legs, which seem to support the backrest. The rich padding and the choice of precious finishes such as velvet make Love a prestigious chair.

Love



CS1885

CS1885-A







Love
Icaro
SkySedia / Chair
Tavolo / Table
Tappeto / RugCS1885-AP15 / S0J
CS4115-FR P15L / P2C
CS7192

Love Sedia / Chair CS21885-A P15 / S0F

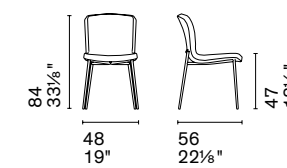
CS1885
CS1885-A
CS1885-MTO

Nota Per le combinazioni disponibili consultare il listino prezzi. / **Note** Please check all available combinations in the price list.



Tra i prodotti più noti e amati di Calligaris, Oleandro si fa riconoscere per la caratteristica schiacciatura dello schienale, presente sia nelle varianti in legno sia in quelle in metallo. La profondità di seduta, l'imbottitura generosa e le linee avvolgenti donano a sedie e sgabelli un comfort extra.

Among Calligaris' most well-known and beloved products, Oleandro distinguishes itself for the characteristic flattened backrest, present in both wood and metal variants. The seat depth, generous padding, and enveloping lines give chairs and stools extra comfort.

Oleandro



CS2034

CS2031

CS2035

CS2032





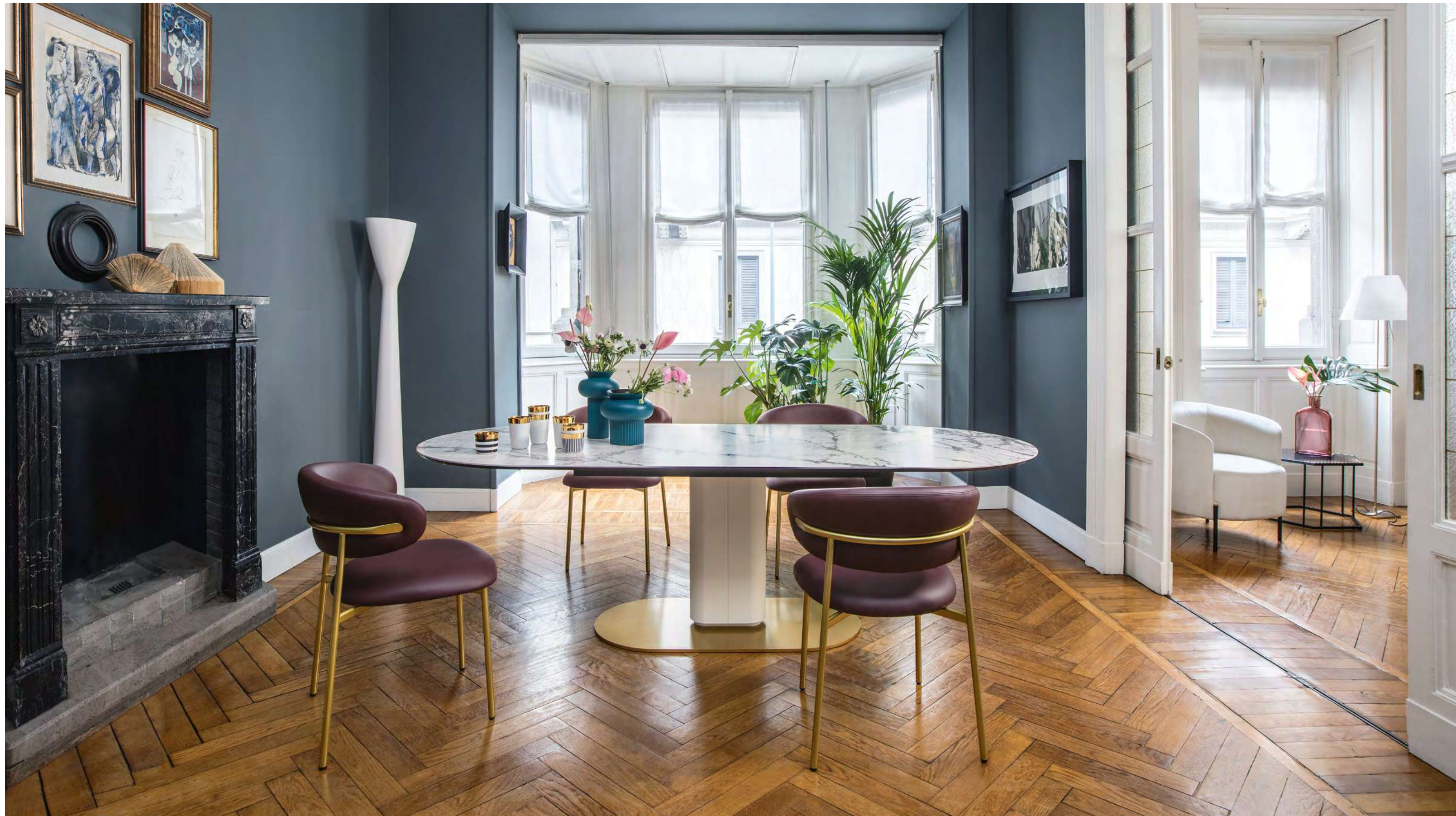





Oleandro Sgabello / Stool CS2032 P175 / SLV







Oleandro Sgabello /Stool CS2035 P12 / SLV

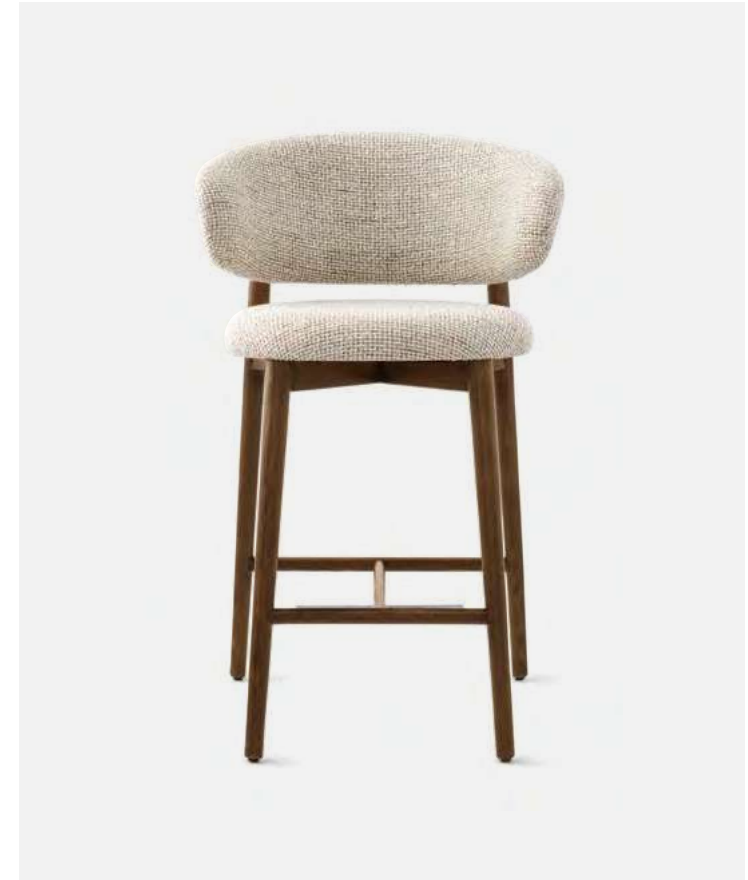

Oleandro Sgabello /Stool CS2035 P12 / SLV

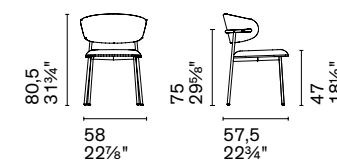

CS2031
CS2031-MTO

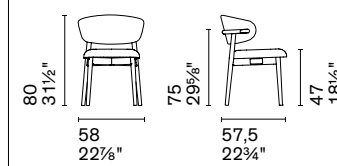

CS2034
CS2034-MTO

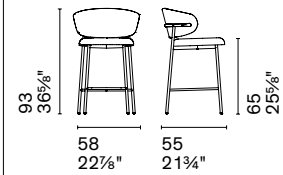

CS2032
CS2032-MTO

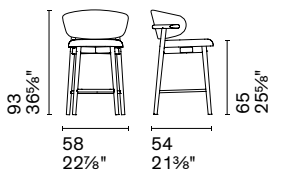

CS2035
CS2035-MTO

Nota Per le combinazioni disponibili consultare il listino prezzi. /**Note** Please check all available combinations in the price list.



Palm risponde all'esigenza di arredare le cucine contemporanee, dove spesso il tavolo da pranzo è sostituito da isole e piani snack. Disponibile con base in legno, metallo o con fusto centrale e pistone a gas, lo sgabello è reso confortevole dalla seduta ergonomica realizzata in materiale schiumato e dal poggiapiedi, presente in tutte le varianti.

Palm meets the need to furnish contemporary kitchens, where the dining table is often replaced by islands and snack counters. Available with base in wood, metal, or with central shaft and gas piston, the stool is made comfortable by the ergonomic seat made of foamed material and by the footrest, present in all variants.

Palm



CS1811

CS1822

CS1827



Palm Sgabello / Stool CS1811 P12 / S96

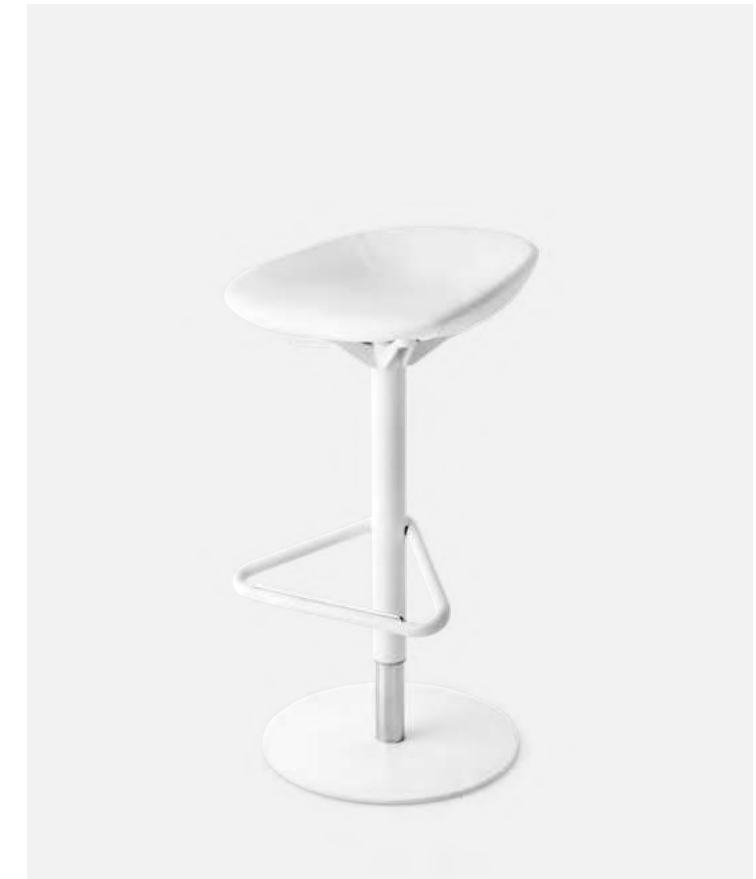

Palm Sgabello / Stool CS1827 P94 / S92

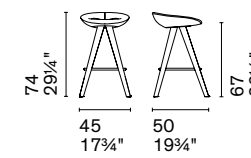

CS1811
CS1811-MTO

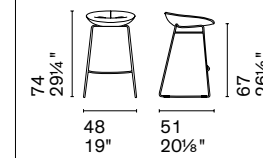

CS1822
CS1822-MTO

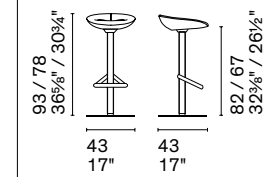

CS1827
CS1827-MTO



Nota Per le combinazioni disponibili consultare il listino prezzi. / **Note** Please check all available combinations in the price list.



Suggerzioni primo Novecento per Parisienne, una sedia che reinterpreta le classiche sedute dei bistrot di Parigi con spirito contemporaneo. Leggera, facile da spostare e impilabile si adatta a qualsiasi contesto abitativo. L'estetica cambia in base alla finitura scelta, trasparente od opaca.

Early 20th-century charm for Parisienne, a chair that reinterprets the classic seats of Paris bistros with a contemporary spirit. Light, easy to move, and stackable, it adapts to any living context. The look changes depending on the chosen finish, transparent or opaque.

Parisiene



CS1263

design by Archirivolto

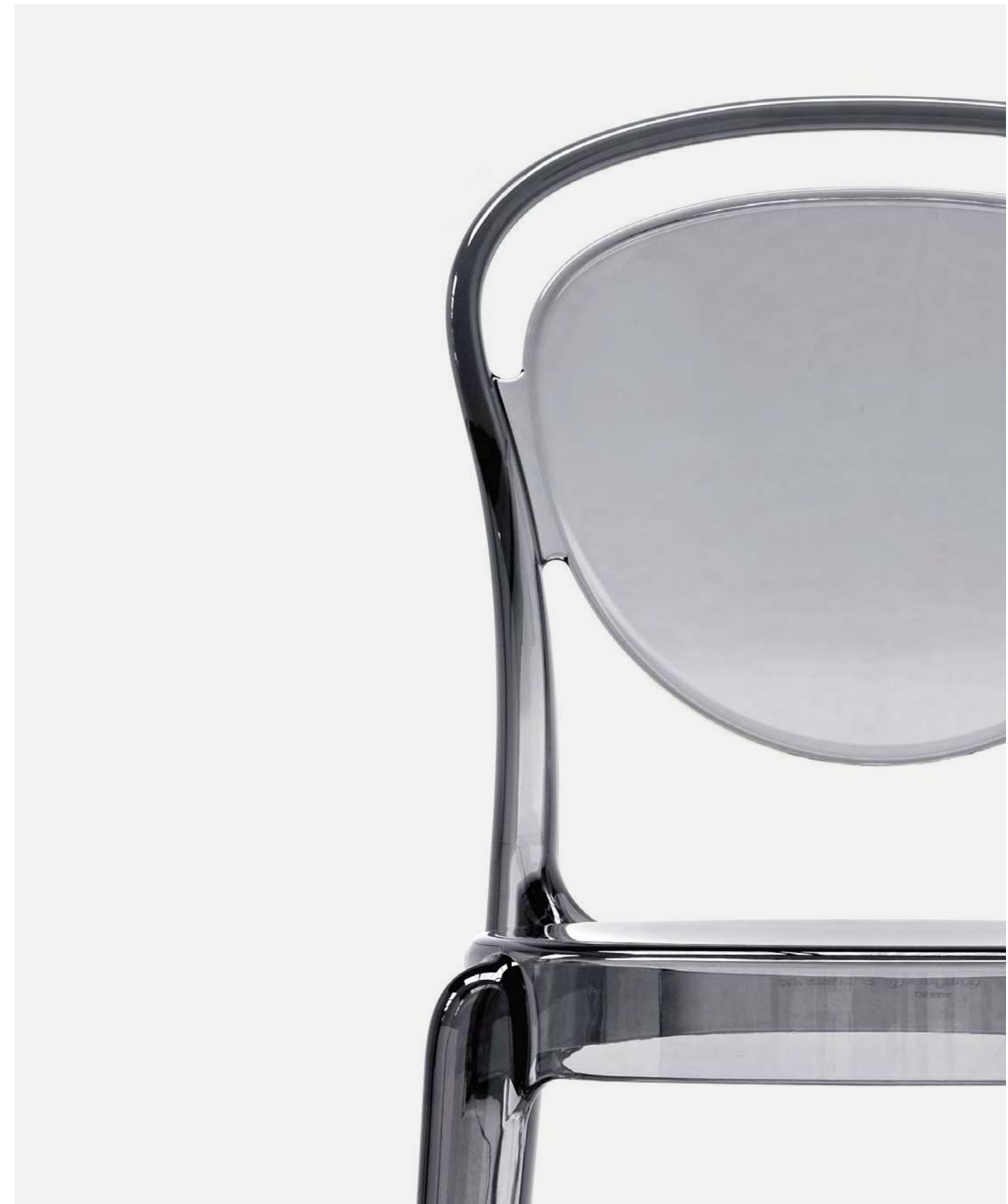





Parisiene Sedia / Chair CS1263 P276



Parisiene Sedia / Chair CS1263 P276

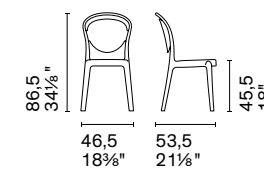

CS1263

Nota Per le combinazioni disponibili consultare il listino prezzi. / **Note** Please check all available combinations in the price list.



Romy è una sedia che fa della comodità la sua stella polare. La seduta, imbottita e super soffice, è dotata di una struttura interna a cinghie elastiche per il massimo comfort. Disponibile con basi in legno o metallo e con diverse tipologie di rivestimento, si inserisce con disinvoltura nella zona dining delle case più classiche.

Romy is a chair that makes comfort its guiding star. The padded and super-soft seat is equipped with an internal structure with elastic straps for maximum comfort. Available with wooden or metal bases and with various upholstery options, it easily fits into the dining area of the most traditional homes.

Romy



CS1912

CS1908

CS1906



Romy Sedia /Chair CS1912 P12 / L08



Romy Sedia /Chair CS1912 P201 / SOC

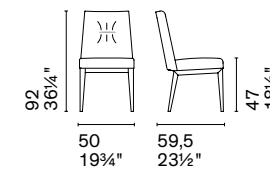

CS1912
CS1912-MTO

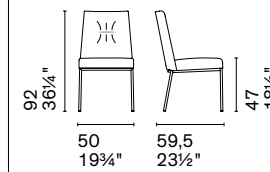

CS1908
CS1908-MTO

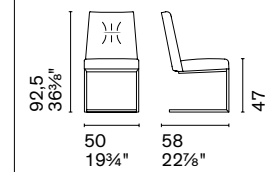

CS1906

Nota Per le combinazioni disponibili consultare il listino prezzi. / **Note** Please check all available combinations in the price list.



Ispirata ai giochi di luce nel mare di Saint Tropez, dell'iconica località francese questa collezione richiama anche il dinamismo. La scocca a effetto trapuntato, in tonalità trasparenti od opache, è montata su diversi basamenti che la rendono ideale accanto a un tavolo da pranzo, ma anche abbinata a una scrivania.

Inspired by the plays of light on the sea of Saint Tropez, this collection also evokes the dynamism of the iconic French location. The quilted-effect shell, in transparent or opaque tones, is mounted on various bases that make it ideal next to a dining table, but also paired with a desk.

Saint Tropez



CS1855

CS1845

CS1858

CS1859



CS1881

CS1879

CS1878





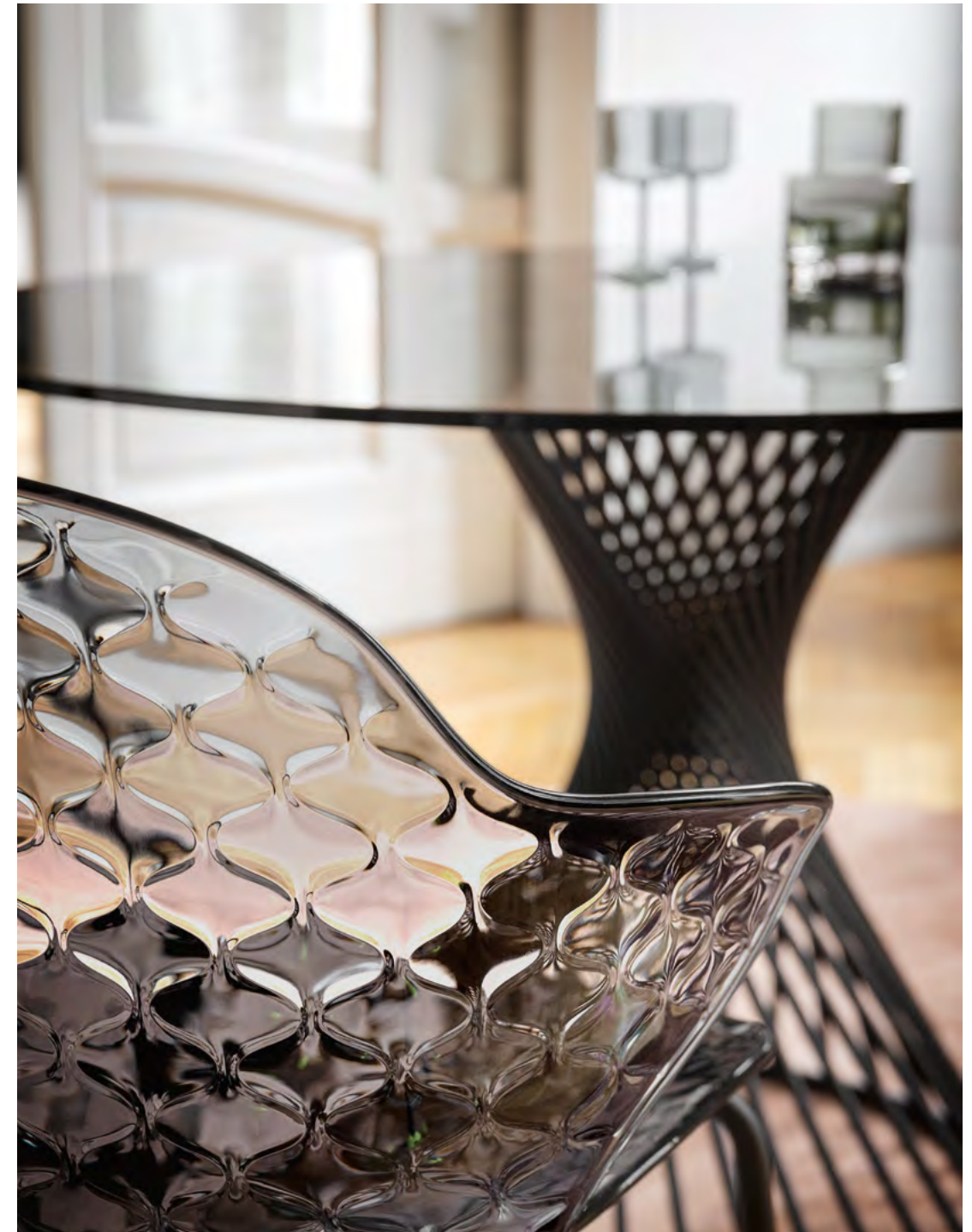



Saint Tropez Sgabello / Stool CS1881 P19W / P848

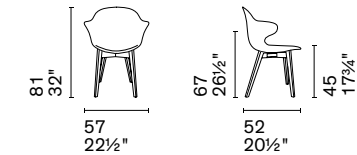

CS1855

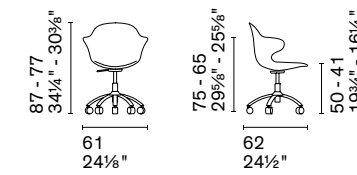

CS1859

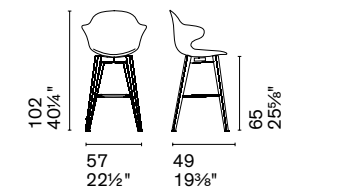
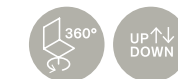

CS1881

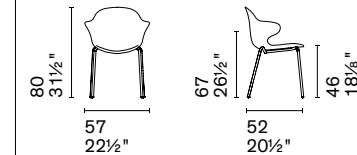

CS1845

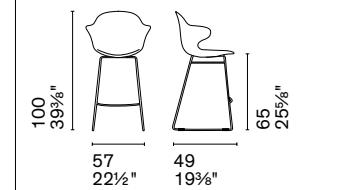
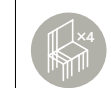

CS1879

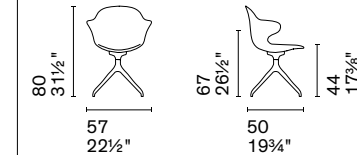

CS1858 180

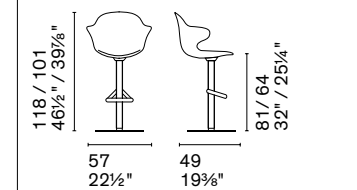

CS1878

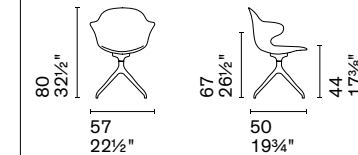

CS1858 360



Nota Per le combinazioni disponibili consultare il listino prezzi. /Note Please check all available combinations in the price list.



Nella sedia Skin, la tradizionale seduta bistrot trova una nuova sintesi contemporanea, sia visiva sia materiale. Merito di linee snelle e decise che ne fanno una sedia leggera ma robusta, versatile e accessibile. Skin è disponibile anche in versione sgabello.

In the Skin chair, the traditional bistro seat finds a new contemporary synthesis, both visual and material. Thanks to slender and decisive lines, it becomes a lightweight yet robust, versatile, and accessible chair. Skin is also available in stool version.

Skin



CS1391

CS1843



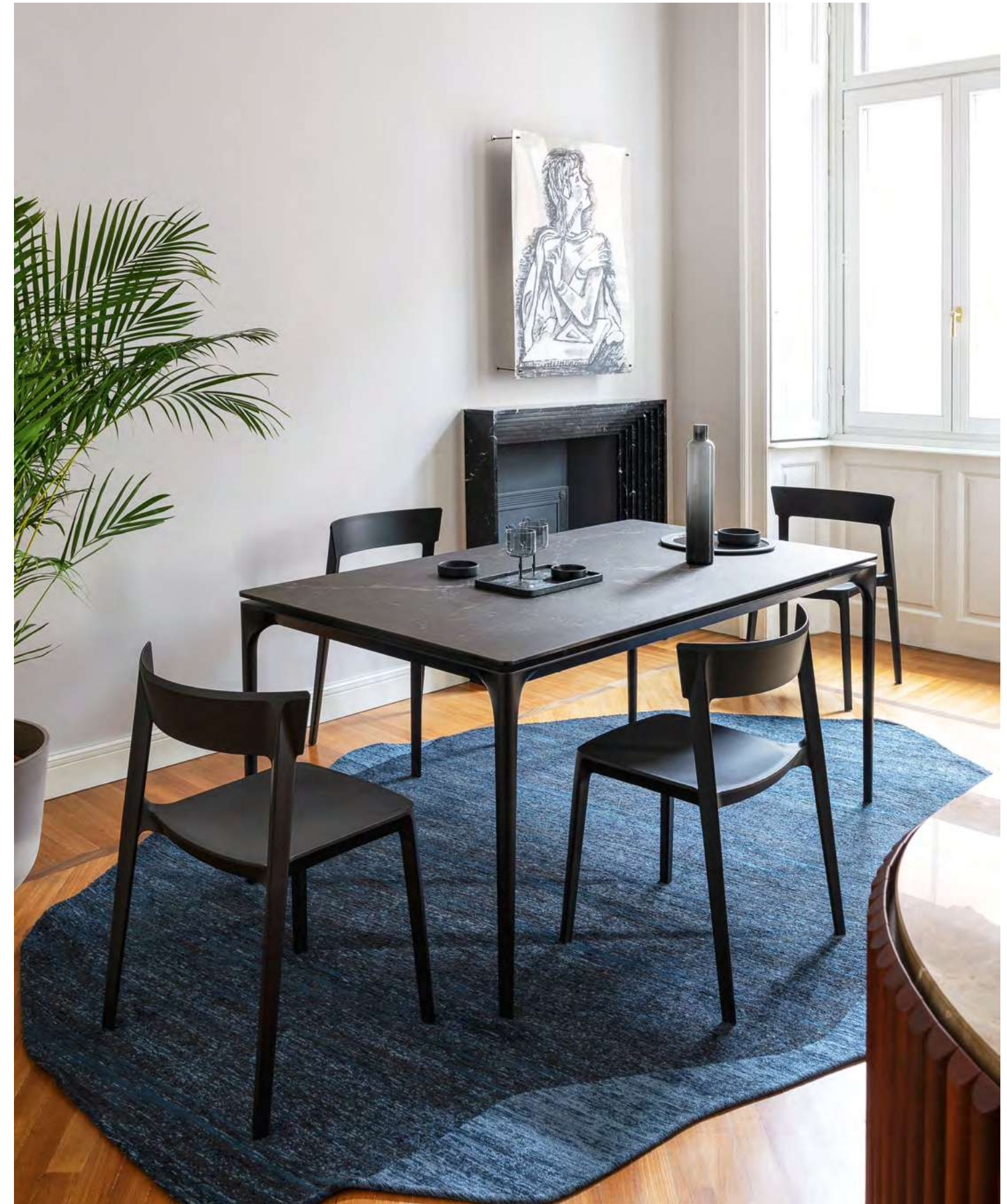



Skin Sgabello /Stool CS1843 P94



Skin Sgabello /Stool CS1843 P900

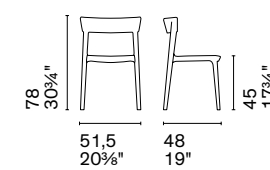

CS1391

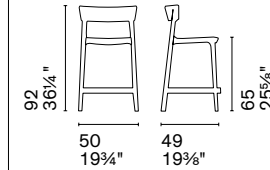

CS1843



Nota Per le combinazioni disponibili consultare il listino prezzi. /**Note** Please check all available combinations in the price list.



Sophia è una sedia semplice benché molto disegnata. La sua caratteristica principale è il gioco di incastri geometrici tra i sottili tubi metallici, su cui sono ancorati lo schienale e la seduta imbottiti e rivestiti. Leggera ma resistente, adatta a ogni tipo di ambiente, Sophia si lascia interpretare anche in base alle finiture scelte per il rivestimento.

Sophia is a simple yet highly designed chair. Its main characteristic is the play of geometric joints between the thin metal tubes that anchor the padded and upholstered backrest and seat. Lightweight yet sturdy, suitable for any environment, Sophia can also be interpreted based on the chosen upholstery finishes.

Sophia



CS1890

design by Carlesi Tonelli

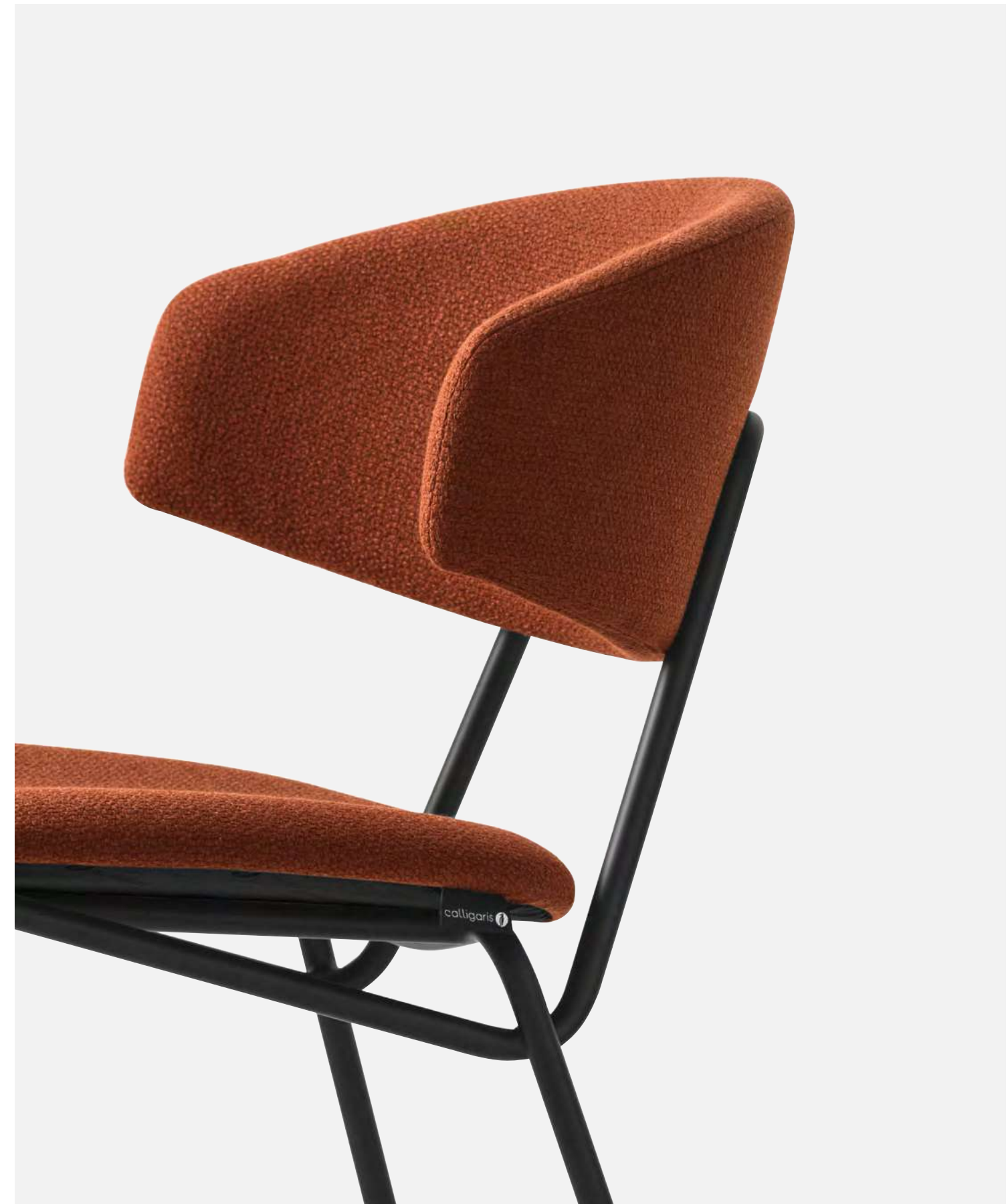

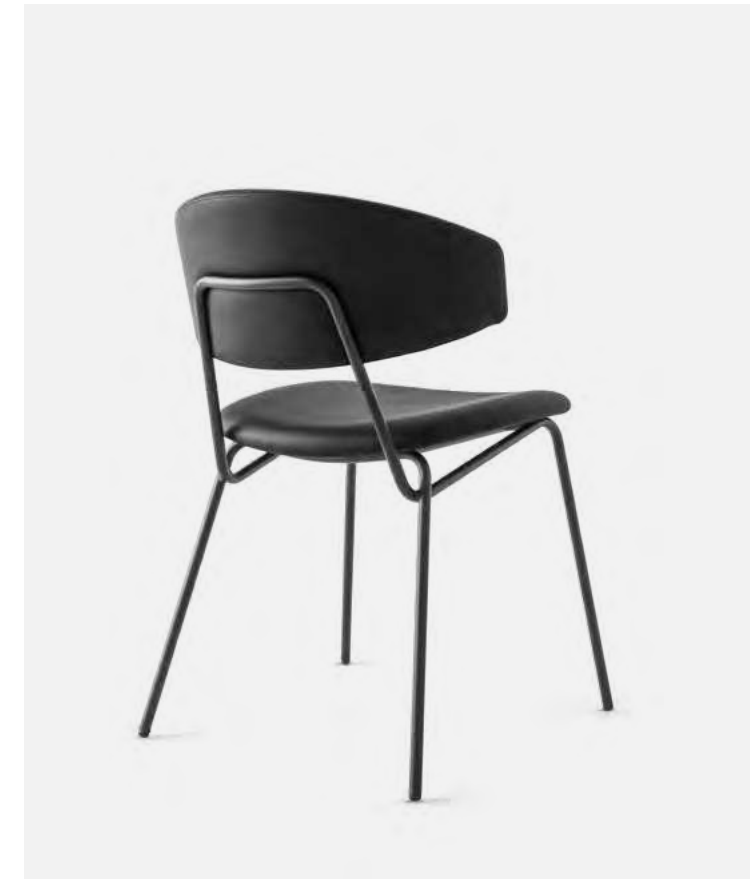
Sophia
BomaSedia / Chair
Tavolo / TableCS1890 P29L / SOF
CS4152-Q P29L / P31C

Sophia

Sedia / Chair

CS1890 P15 / 683

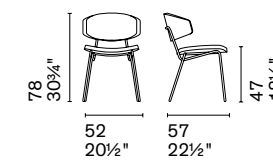
CS1890
CS1890-MTO

Nota Per le combinazioni disponibili consultare il listino prezzi. / **Note** Please check all available combinations in the price list.



Sweel unisce una base dalle linee slanciate a una seduta accogliente dalle forme squadrate. Tra le molte possibilità di rivestimento disponibili, spicca la versione bicolore che permette di abbinare due tessuti di colori diversi, oppure un tessuto e una pelle. Sweel è disponibile anche in versione sgabello.

Sweel combines a base with slender lines with a cozy seat with square shapes. Among the many available covering options, the two-tone version stands out, allowing you to match two fabrics of different colours or a fabric and a leather. Sweel is also available as a stool.

Sweel



CS2207

CS2211

CS2215

CS2214





Sweel
Twins
Susan
Madison

Sedia / Chair
Tavolo / Table
Lazy Susan
Tappeto / Rug

CS2211 P15 / S8S
CS4153-FD P15 / P15L
CS4157-FD 95 MTO P18C
CS7266

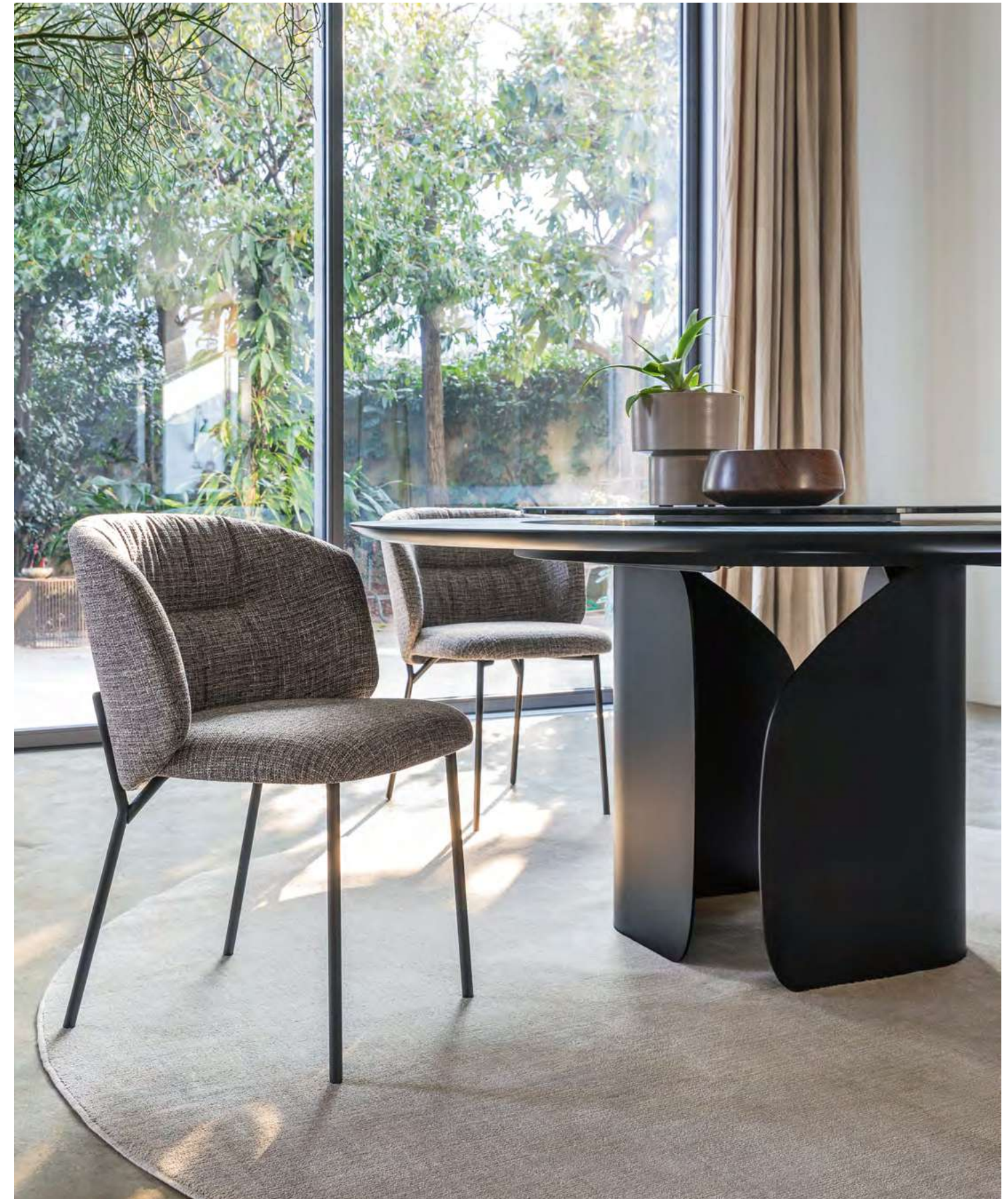



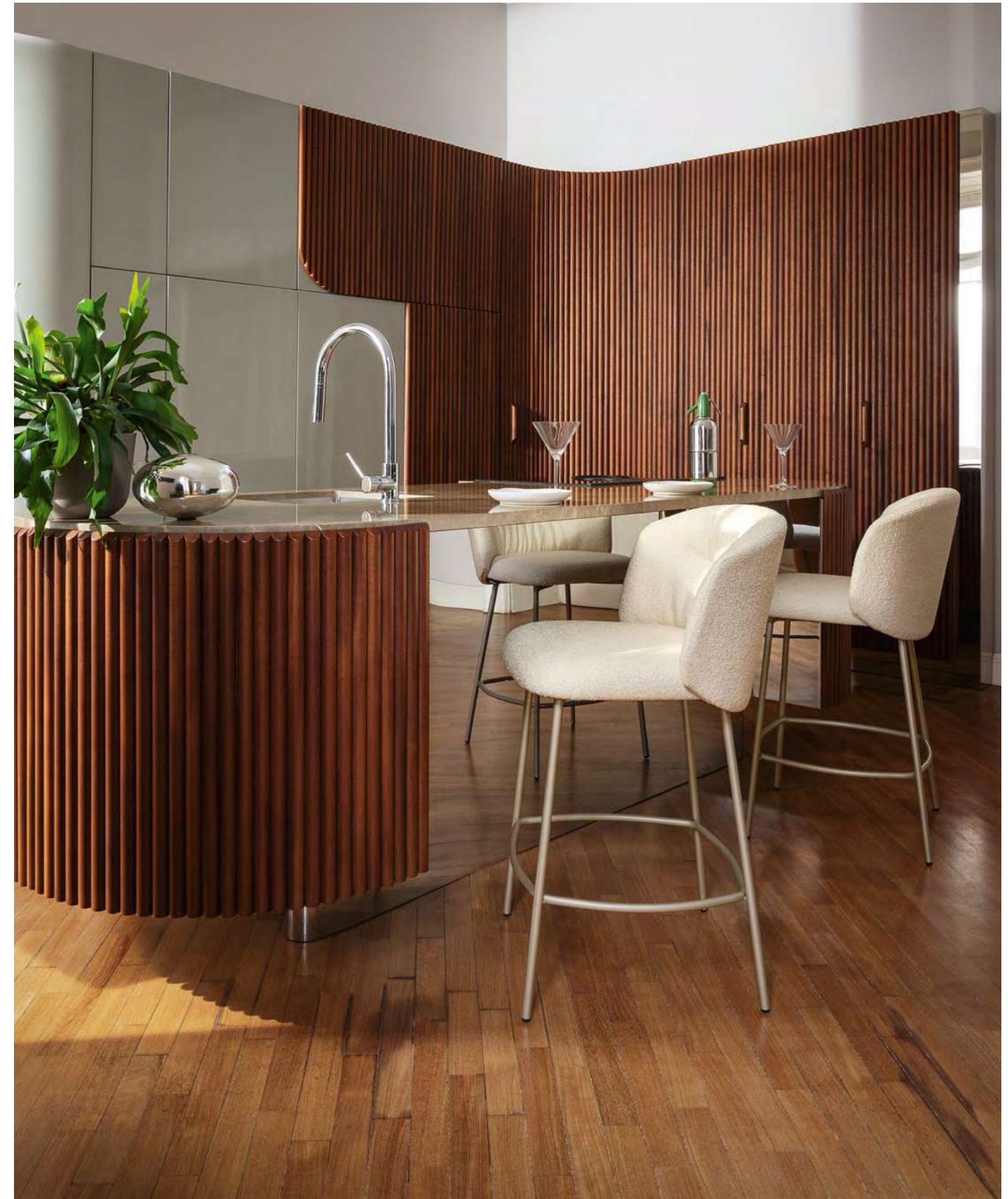





Sweel Sgabello / Stool CS2215 P15L / S8S



Sweel Sedia / Chair CS2207 P15L SQN

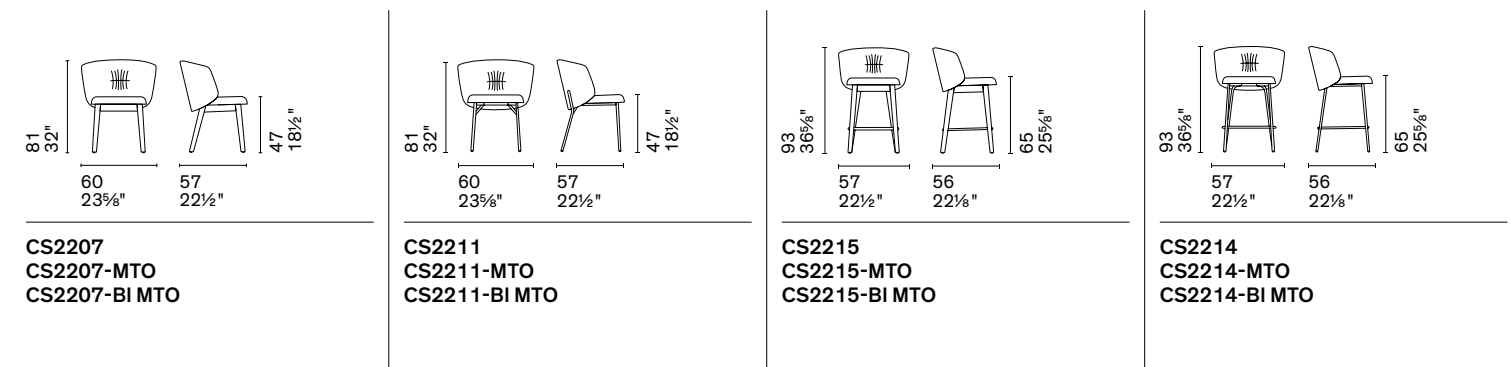

Nota Per le combinazioni disponibili consultare il listino prezzi. / **Note** Please check all available combinations in the price list.



Coco	298
Dalia	302
Fifties	308
Haven	312
Holly	318
Jill	322
Lazy	326
Mara	334
Medea	342
Oleandro	346
Pulse	352
Quadrotta	356
Rendez Vous	362
Rio	366
Shape	372

Coco è una lounge dalle linee anni Cinquanta che rende omaggio allo stile etereo ed elegante della mitica Mademoiselle Coco. Caratterizzata dal contrasto tra l'esile struttura metallica e i generosi elementi imbottiti, Coco assume il carattere desiderato in base alle finiture e al rivestimento scelti.

Coco is a lounge chair with 1950s lines that pays homage to the ethereal and elegant style of the legendary Mademoiselle Coco. Characterized by the contrast between the slender metal structure and the generous padded elements, Coco takes on the desired character based on the chosen finishes and covering.

Coco



CS3395

design by Busetti Garuti Redaelli



Coco Poltrona /Lounge chair CS3395



Coco Poltrona /Lounge chair CS3395

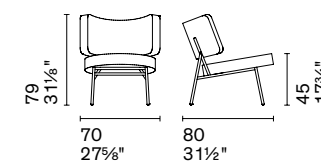

CS3395 1300 MTO

Nota Per le combinazioni disponibili consultare il listino prezzi. /**Note** Please check all available combinations in the price list.



La poltrona Dalia combina comfort e design. Imbottita, disponibile in una vasta gamma di tessuti e pelli, e caratterizzata dal particolare basamento a trespolo, è una poltrona perfetta per il relax e la lettura, con una fusione di stili mid-century e nordico. Dalia è anche dotata di un meccanismo girevole.

The Dalia armchair combines comfort and design. Upholstered, available in a wide range of fabrics and leathers, and characterized by the particular trestle base, it is a perfect armchair for relaxation and reading, with a fusion of mid-century and Nordic styles. Dalia also features a swivel mechanism.

Dalia



CS3454

CS3454

design by Stefano Spessotto

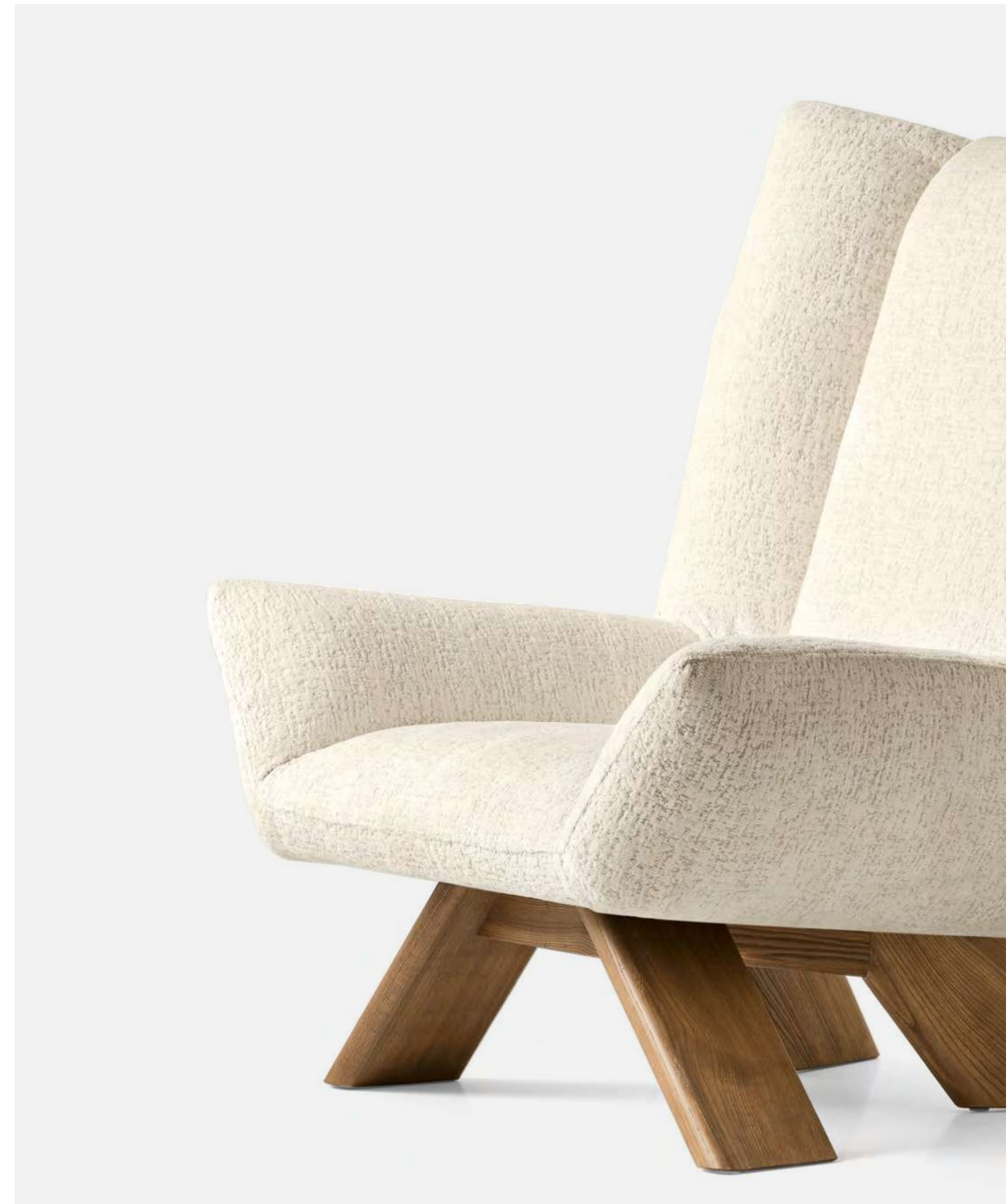



Dalia Poltrona /Lounge chair CS3454 P15 / T2N



Dalia Poltrona /Lounge chair CS3454 P15 / T2N

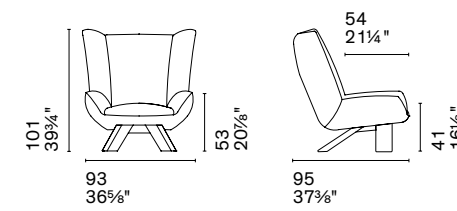

CS3454-DTP1000

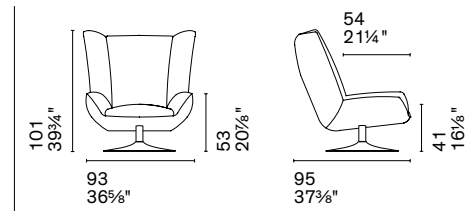

CS3454-DTP1N00



Nota Per le combinazioni disponibili consultare il listino prezzi. / **Note** Please check all available combinations in the price list.

Dell'omonima collezione di sedie, Fifties riprende le suggestioni vintage e l'abbinamento tra la struttura sottile in metallo e gli elementi imbottiti. A cambiare sono le dimensioni, più generose, le proporzioni tra gli elementi e l'inclinazione del sedile, che guardano alla comodità di una poltrona facilitando una seduta più rilassata.

From the chair collection of the same name, Fifties interprets the vintage vibes and the combination of the slender metal structure with padded elements. What changes are the more generous dimensions, the proportions between the elements, and the inclination of the seat, which look to the comfort of an armchair, facilitating a more relaxed sitting position.

Fifties



CS3416

design by Buseti Garuti Redaelli

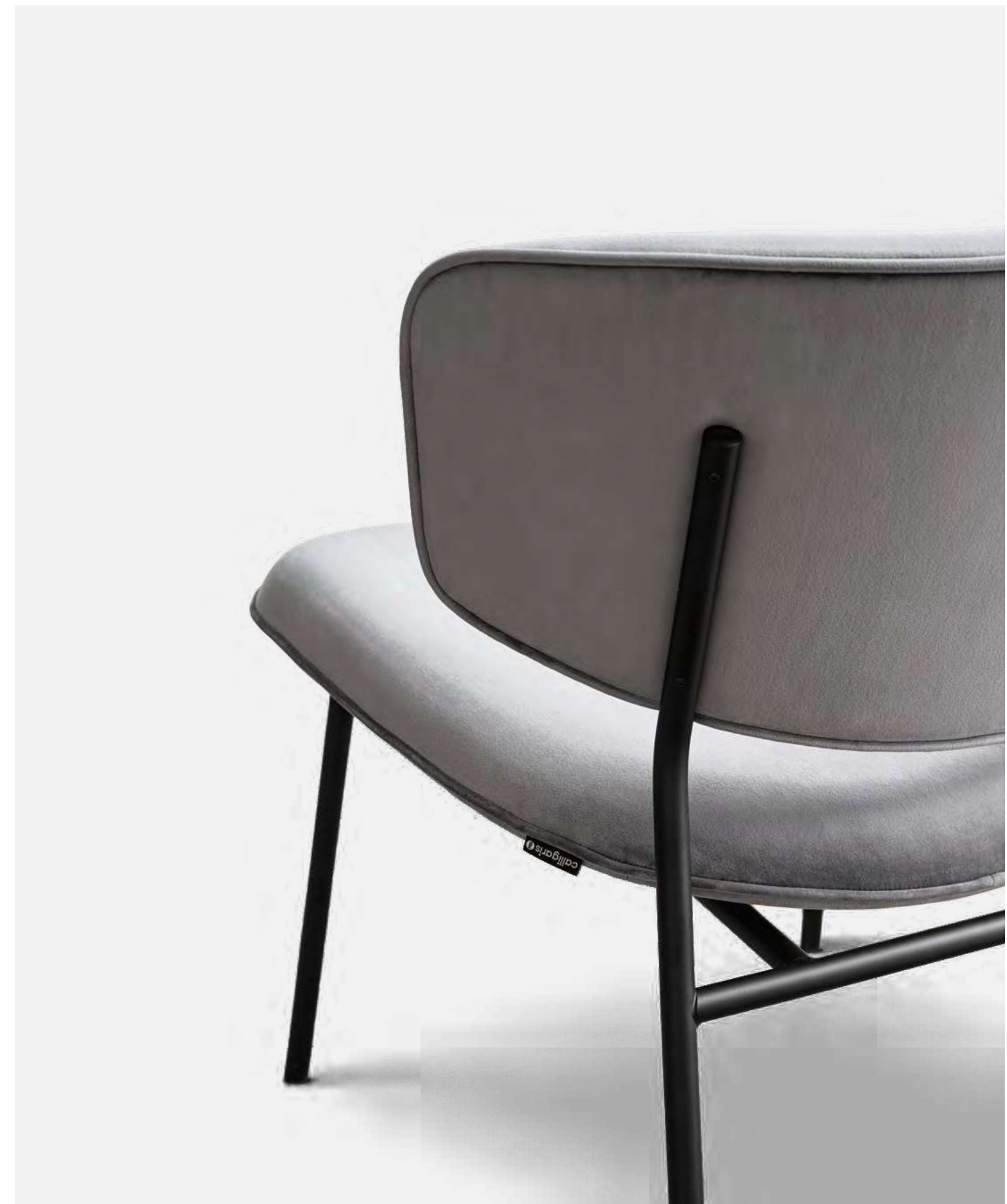

Fifties Poltrona / Lounge chair CS3416 P15 / S0L



Fifties Poltrona / Lounge chair CS3416 P175 / S0H

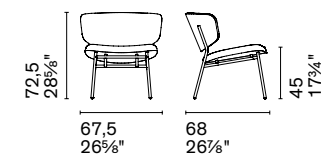

CS3416 1300 MTO

Nota Per le combinazioni disponibili consultare il listino prezzi. / **Note** Please check all available combinations in the price list.



Il design della poltroncina Haven nasce dalla volontà di offrire il massimo comfort con il minimo ingombro. Le forme arrotondate e i braccioli ripiegati verso l'interno evocano una sensazione di calore e sicurezza, come quella di un abbraccio. La poltroncina è disponibile anche in versione girevole.

The design of the Haven armchair stems from the desire to offer maximum comfort with minimal space. The rounded shapes and the armrests folded inward evoke a feeling of warmth and safety, like that of a hug. The armchair is also available in swivel version.

Haven



CS3444



CS3444



Haven Poltrona / Lounge chair CS3444 SWF
Mushroom Tavolino / Coffee table CS5140-A P15L / GM3
Roche Tappeto / Rug CS7258

Haven Poltrona / Lounge chair CS3444 SWF
Tweet Tavolino / Coffee table CS5085-D P15 / P12



Haven Poltrona /Lounge chair CS3444 SWF
 Roche Tappeto /Rug CS7258



Technical Info



Haven Poltrona /Lounge chair CS3444 T2H

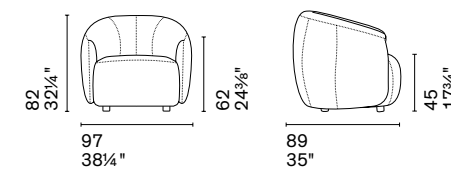

CS3444-DTP1000 MTO

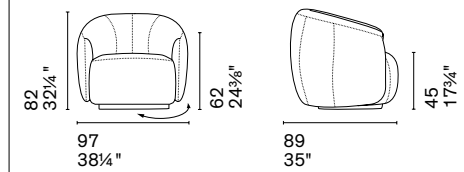

CS3444-DTP1N00



Nota Per le combinazioni disponibili consultare il listino prezzi. /**Note** Please check all available combinations in the price list.



La sedia Holly rinasce in versione lounge ed è ancora più confortevole. Lo schienale generoso offre la possibilità di appoggiare comodamente le braccia, mentre il sedile profondo facilita una seduta rilassata, benché meno informale di quella che si avrebbe in una poltrona. Caratteristica che la rende ideale per arredare qualsiasi spazio domestico.

The Holly chair is reborn in a lounge version and is even more comfortable. The generous backrest offers the possibility of resting your arms comfortably, while the deep seat facilitates a relaxed sitting position, although less informal than what you would have with an armchair. A characteristic that makes it ideal for furnishing any domestic space.

Holly



CS3417

design by Busetto Garuti Redaelli



Holly Poltrona / Lounge chair CS3417 P15 / S8S



Holly Poltrona / Lounge chair CS3417 P15 / S0F

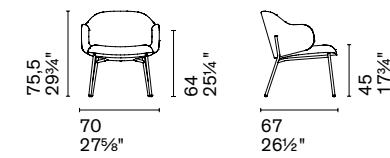

CS3417 1300 MTO

Nota Per le combinazioni disponibili consultare il listino prezzi. / **Note** Please check all available combinations in the price list.



Jill è una collezione di imbottiti dalla presenza dinamica e dalle forme piene, ispirata al design anni Settanta e in particolare allo stile di Pierre Paulin. La poltrona lounge riprende la silhouette a trapezio e i tagli verticali del divano, dando vita a una poltroncina compatta capace di offrire un caldo abbraccio nei momenti di relax.

Jill is a collection of upholstered furniture with a dynamic presence and full shapes, inspired by the design of the 1970s and in particular the style of Pierre Paulin. The lounge armchair recalls the trapezoidal silhouette and vertical cuts of the sofa, creating a compact armchair capable of offering a warm embrace in moments of relaxation.

Jill



CS3446



CS3446

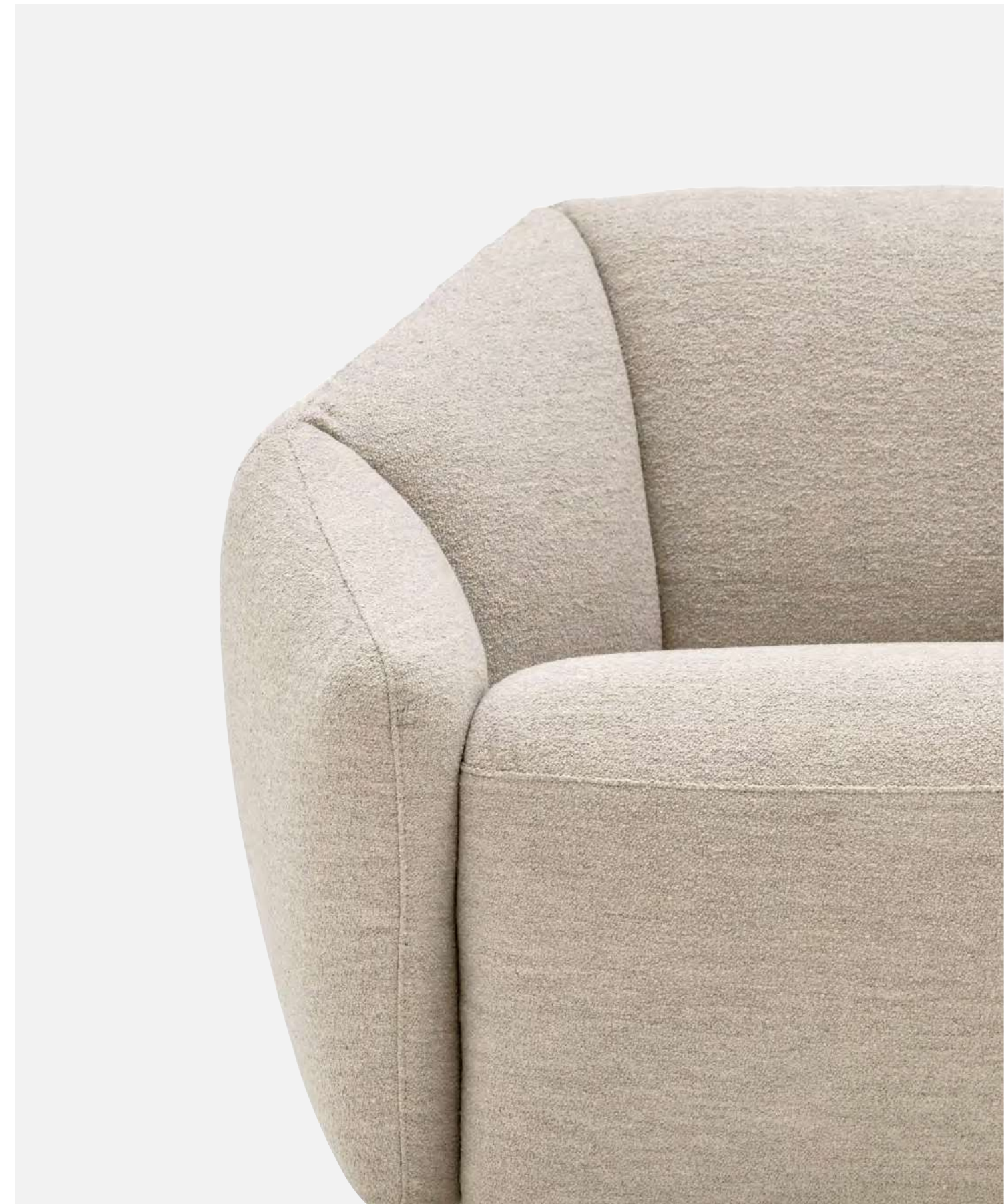

Jill Poltrona / Lounge chair CS3446 SHZ
 Abrey Tavolino / Coffee table CS5137-AP12 / P12



Jill Poltrona / Lounge chair CS3446 SHZ

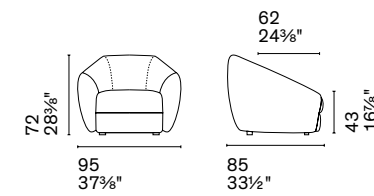

CS3446-DTP1000

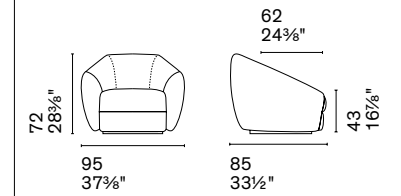

CS3446-DTP1N00



Nota Per le combinazioni disponibili consultare il listino prezzi. / **Note** Please check all available combinations in the price list.



Il design di Lazy si ispira alle iconiche sedute a uovo. Le linee curve, la seduta accogliente, i meccanismi basculante e girevole e gli accessori come i morbidi cuscini e il poggiapiedi opzionale ne fanno un emblema di comfort, trasformandola nella perfetta poltrona da lettura.

Lazy's design is inspired by the iconic egg seats. Its curved lines, welcoming seat, tilting and swivelling mechanisms, and accessories like the soft cushions and optional footrest make it a symbol of comfort, transforming it into the perfect reading armchair.

Lazy



CS3373-W

CS3373-W

CS3373-C

CS3373-C

CS3373 360

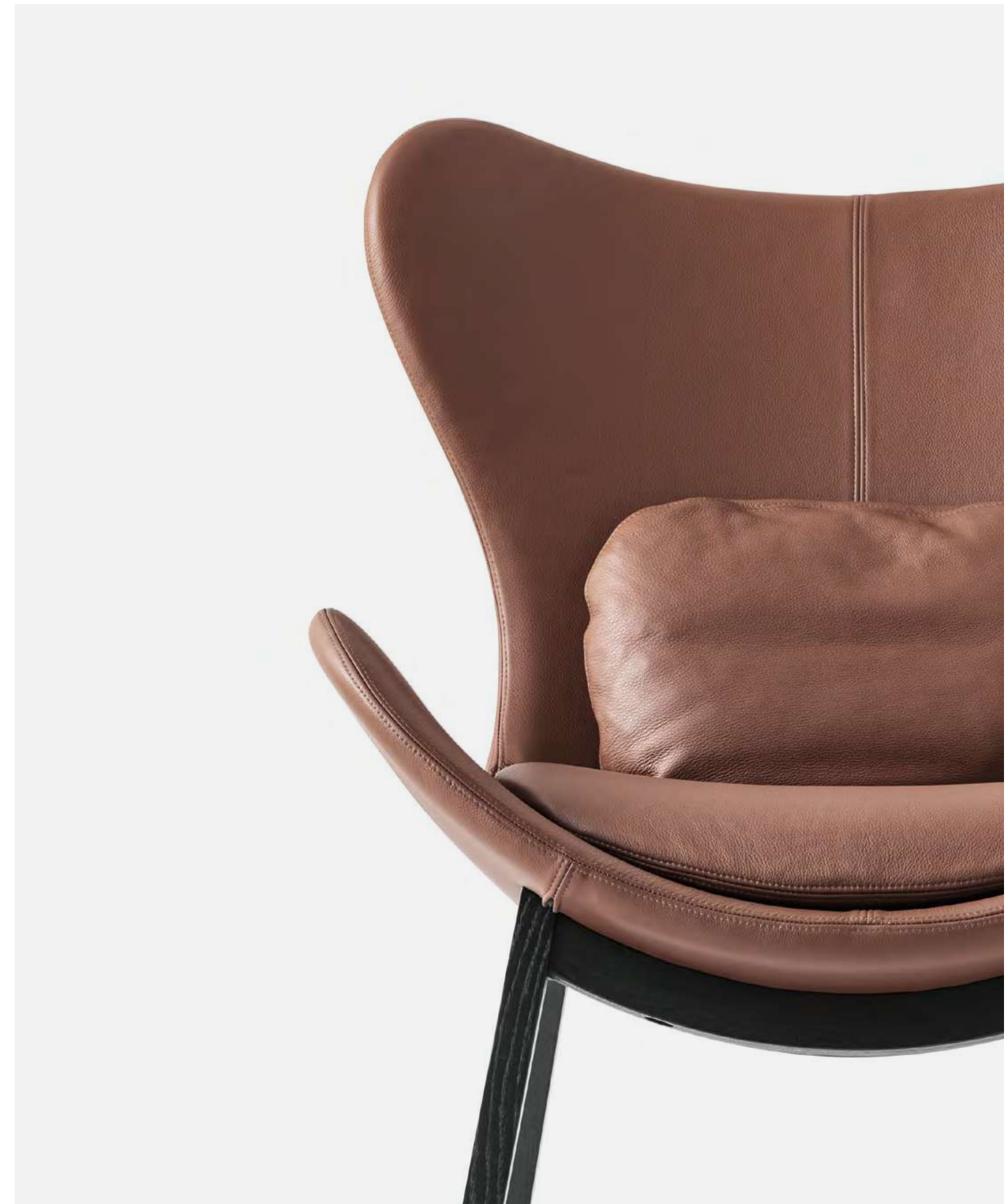



Lazy	Poltrona / Lounge chair	CS3373-C P15 / L3E
Lazy	Pouf / Ottoman	CS3373-C P15 / L3E
Arena	Tavolino / Coffee table	CS5118-M P15 / P15L-R04
Arena	Tavolino / Coffee table	CS5118-P P15 / P15L-315
Chinese	Tappeto / Rug	CS7209



Lazy Poltrona / Lounge chair CS3373-W P15L / S5T
 Lazy Pouf / Ottoman CS3373-W P15L / S5T
 Abrey Tavolino / Coffee table CS5137-A P15L / P18C



Technical Info

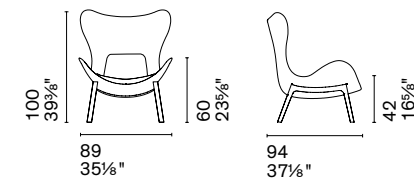

CS3373-W 1310 MTO

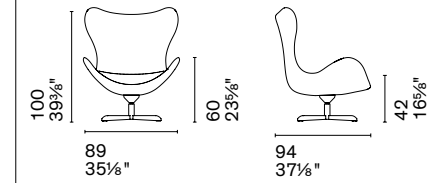

CS3373-C 1310 MTO

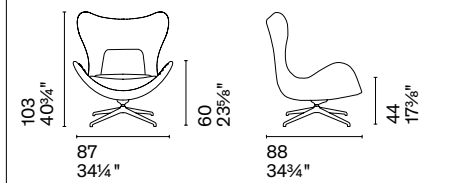

CS3373 360 1310 MTO

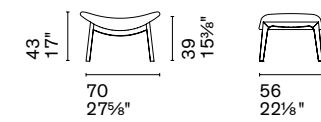

CS3373-W 1320 MTO

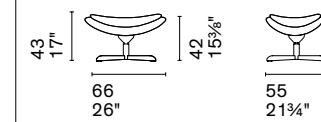

CS3373-C 1320 MTO



Nota Per le combinazioni disponibili consultare il listino prezzi. /Note Please check all available combinations in the price list.



La poltrona Mara è un capolavoro di comfort e design. Imbottita e rivestita in tessuto o pelle, è arricchita nella parte posteriore da due inserti in legno. Con un'ampia scelta di rivestimenti e colori, Mara è la perfetta espressione del concetto di cocooning, un'esperienza tangibile di comfort e relax. Anche in versione girevole.

The Mara armchair is a masterpiece of comfort and design. Padded and upholstered in fabric or leather, it is enriched in the back by two wooden inserts. With a wide choice of upholstery and colours, Mara is the perfect expression of the cocooning concept, a tangible experience of comfort and relaxation. Also available in a swivel version.

Mara



CS3456

design by Busetti Garuti Redaelli

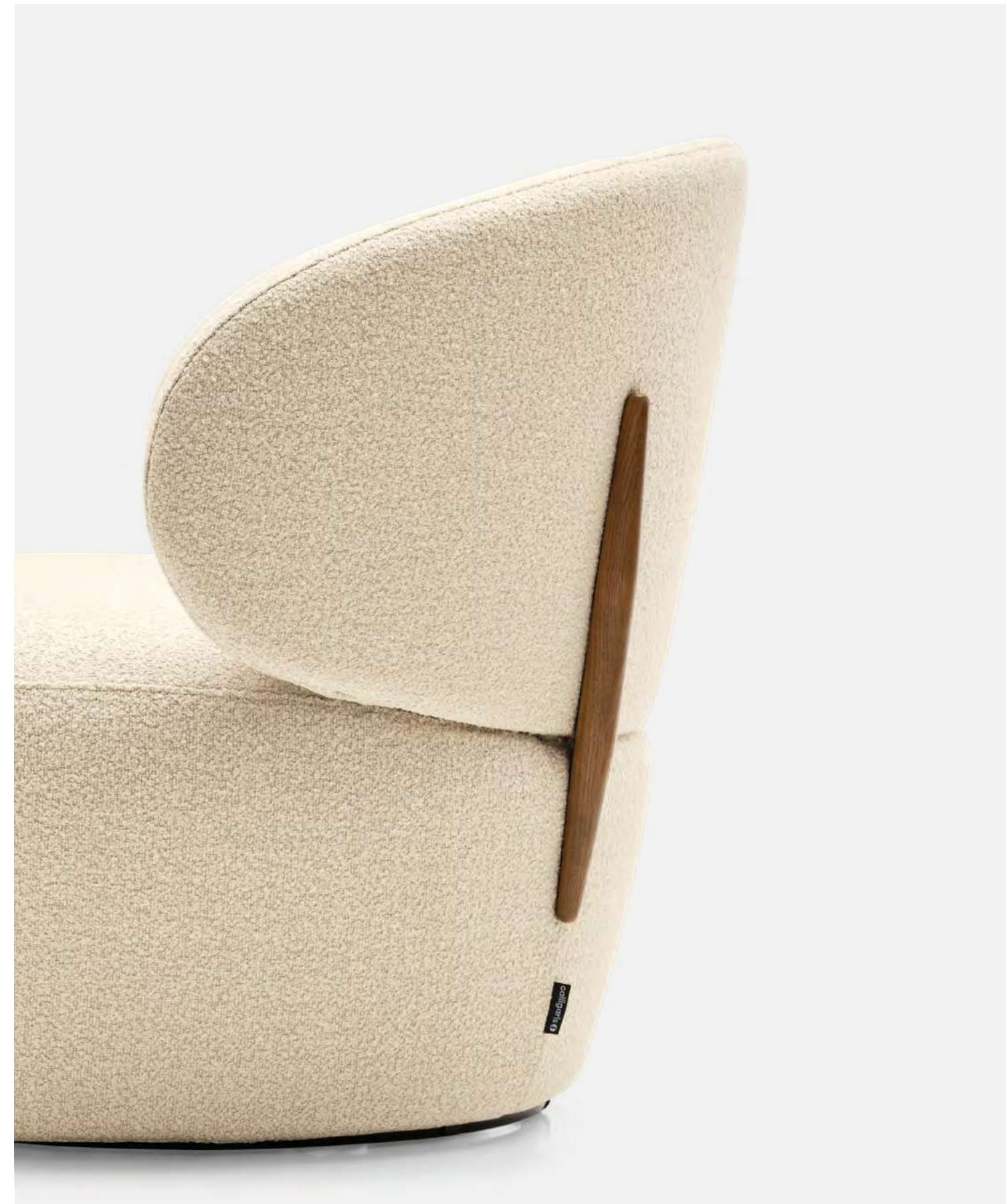



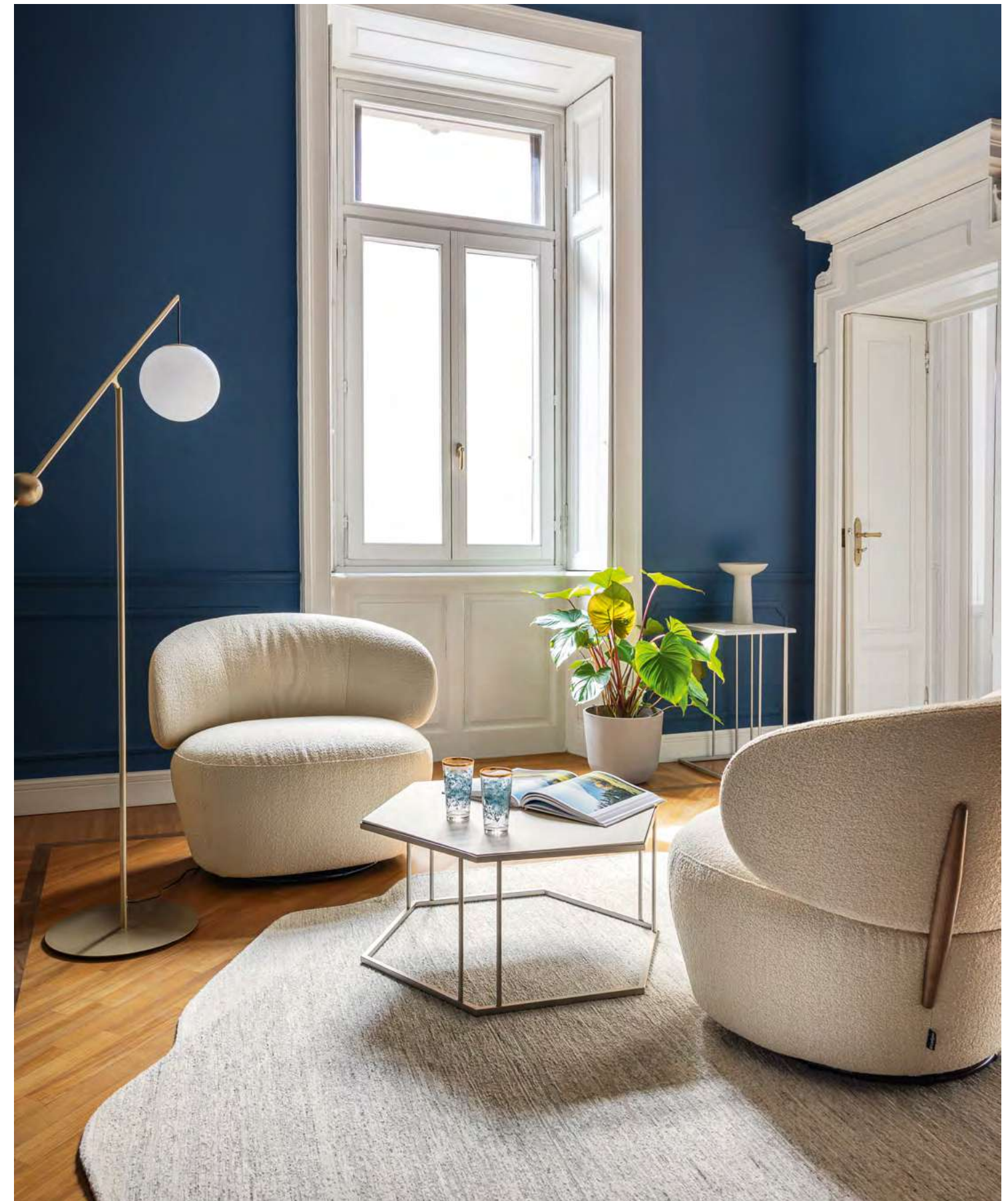

Mara
Thin
Thin
Madison

Poltrona /Lounge chair CS3456 P15L / T07
Tavolino /Coffee table CS5119-QM P15
Consolle /Console CS5120 P15
Tappeto /Rug CS7266



Mara Poltrona /Lounge chair CS3456 P15L / T07

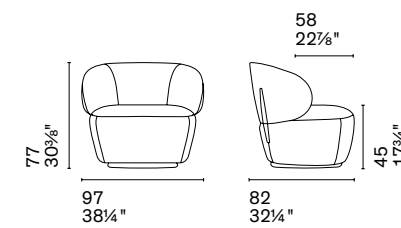

CS3456



Nota Per le combinazioni disponibili consultare il listino prezzi. /**Note** Please check all available combinations in the price list.



Medea è una lounge che racchiude alcuni degli stilemi tipici di Calligaris: ispirazione classica, linee morbide, base in legno ed estrema versatilità. Per le sue dimensioni compatte e l'estetica elegante, Medea è perfetta per creare dei salottini dall'atmosfera intima e completare l'arredamento del living o della zona notte.

Medea is a lounge chair that encapsulates some of Calligaris' typical stylistic elements: classical inspiration, soft lines, wooden base, and extreme versatility. Due to its compact size and elegant look, Medea is perfect for creating lounges with an intimate atmosphere and completing the furnishings of the living room or night area.

Medea



CS3407



Medea Poltrona /Lounge chair CS3407 P15L / SWA



Medea Poltrona /Lounge chair CS3407 P12 / SQR

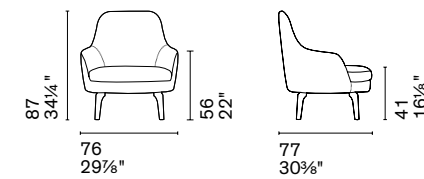

CS3407-DTP1000 MTO

Nota Per le combinazioni disponibili consultare il listino prezzi. / **Note** Please check all available combinations in the price list.



Con la sua struttura in legno e i due voluminosi elementi imbottiti, Oleandro lounge è la seduta ideale per collegare l'ambiente dining al living. Accogliente, morbida e avvolgente, riprende la caratteristica schiacciatura dello schienale che ha reso l'omonima sedia un grande successo.

With its wooden structure and two voluminous padded elements, the Oleandro lounge chair is the ideal seat to connect the dining area to the living room. Cozy, soft, and enveloping, it echoes the characteristic flattened backrest that made the homonymous chair a great success.

Oleandro



CS3452

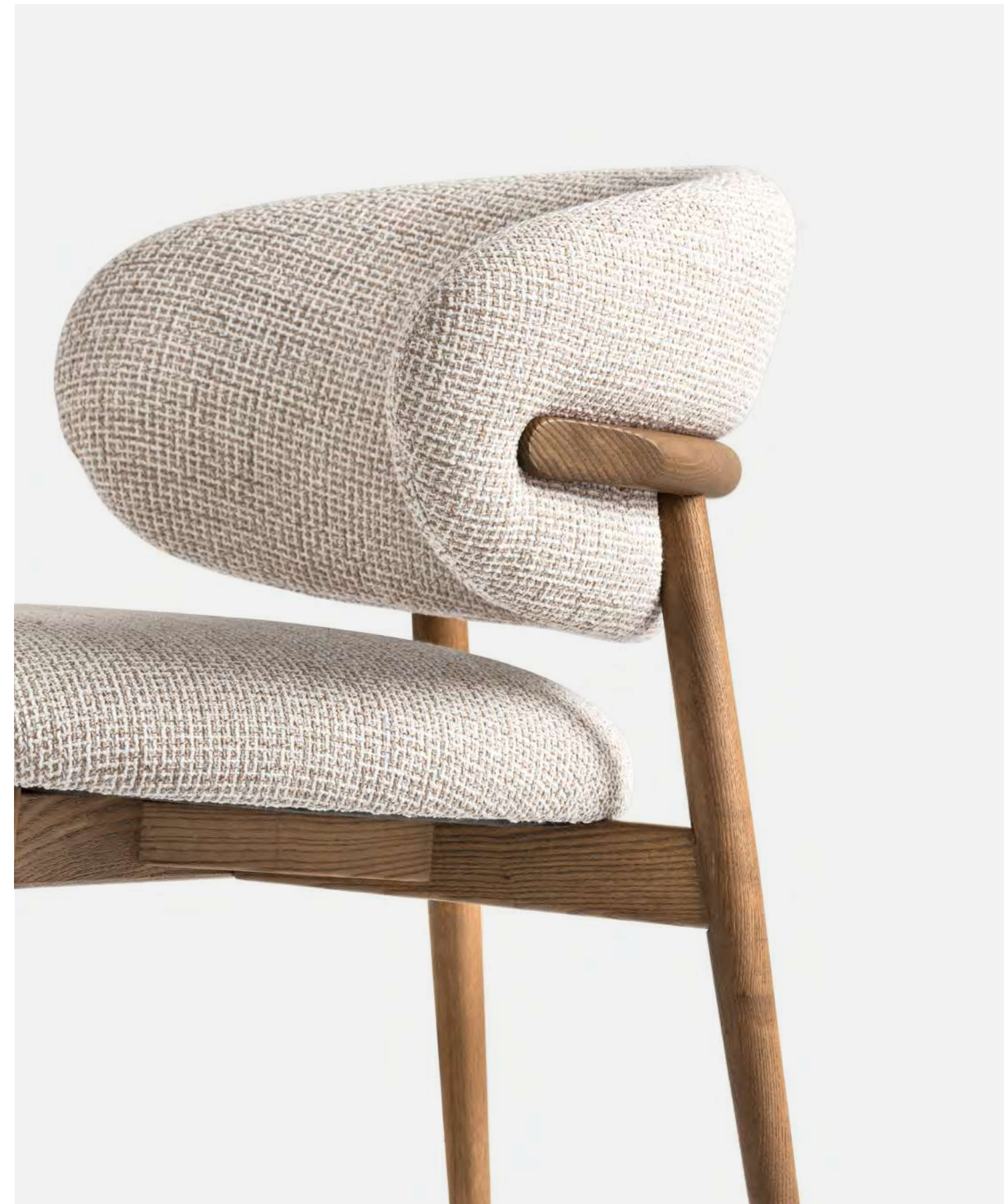



Oleandro
Madison

Poltrona / Lounge chair
Tappeto / Rug

CS3452 P15L / S8S
CS7266



Oleandro Poltrona / Lounge chair CS3452 P15L / S8S

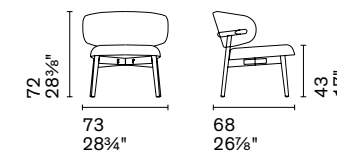

CS3452 1300 MTO

Nota Per le combinazioni disponibili consultare il listino prezzi. / **Note** Please check all available combinations in the price list.



Con la poltrona Polse, il relax trova una nuova dimensione. Tra schienale alto, forme accoglienti e imbottiture generose, il comfort più completo si raggiunge grazie al meccanismo elettrico che, avviato con pulsanti nascosti fra seduta e bracciolo, fa inclinare lo schienale e comparire il comodo poggiatesta.

With the Polse armchair, relaxation finds a new dimension. Between the tall backrest, welcoming shapes, and generous padding, the most complete comfort is achieved thanks to the electric mechanism that, activated with buttons hidden between the seat and armrest, tilts the backrest and reveals the comfortable footrest.

Polse



CS3428



Polse Poltrona / Lounge chair CS3428 P16 / S8S



Polse Poltrona / Lounge chair CS3428

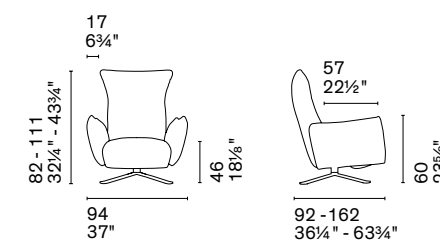

CS3428-DTP1X11 MTO

Nota Per le combinazioni disponibili consultare il listino prezzi. / **Note** Please check all available combinations in the price list.



La poltrona Quadrotta si riconosce per lo schienale morbido e il sedile alto e voluminoso, con struttura interna a cinghie elastiche che ne massimizza il comfort. Caratterizzata dai piedini in metallo, che seguono la curva della seduta e dello schienale, può essere rivestita in diversi materiali, anche con abbinamento bicolore.

The Quadrotta armchair distinguishes itself through its soft backrest and tall and voluminous seat, with an internal structure with elastic straps that maximizes comfort. Characterized by metal feet, which follow the curve of the seat and backrest, it can be upholstered in several materials, also with a two-tone combination.

Quadrotta



CS3409

design by Archirivolto

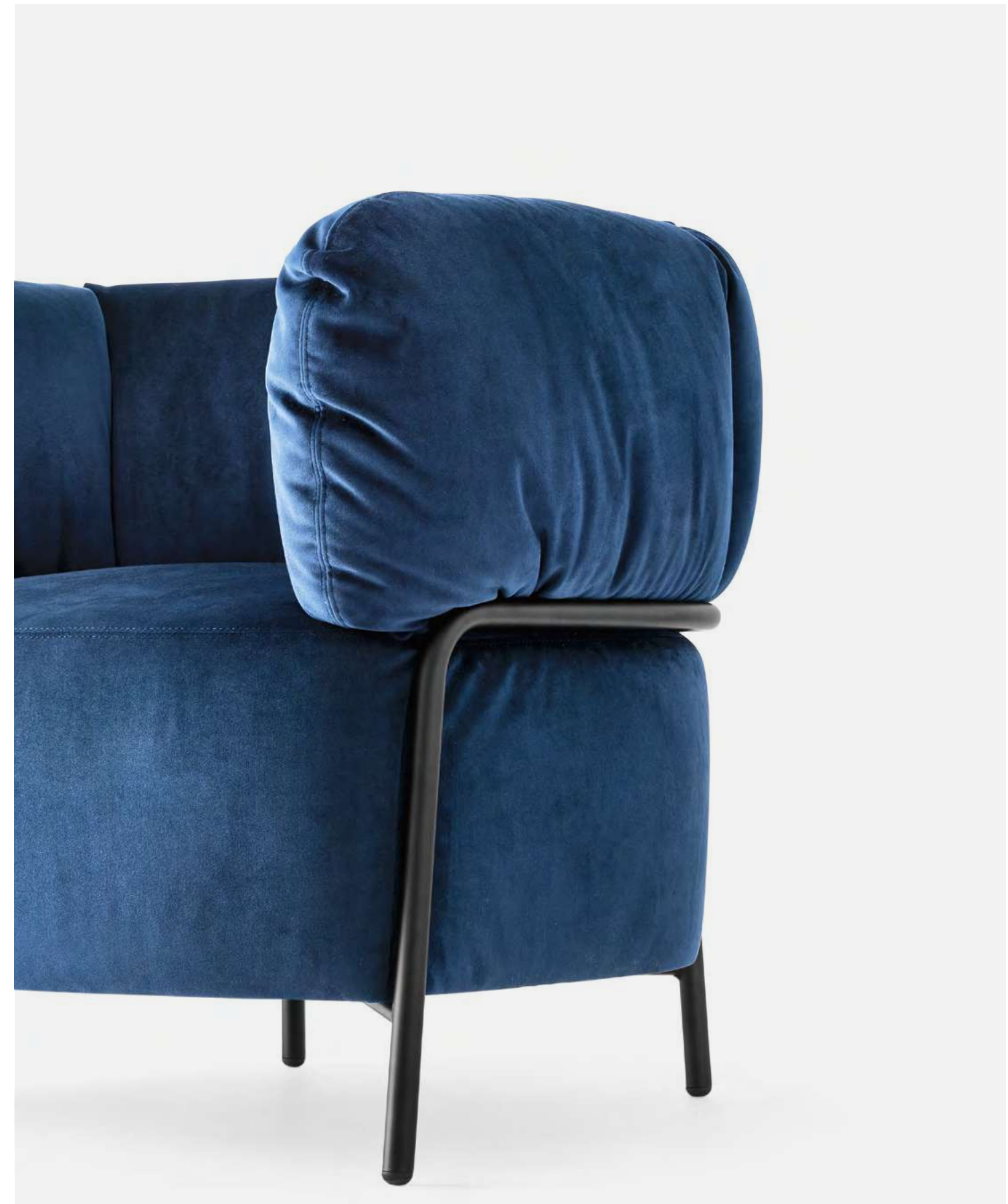



Quadrotta Poltrona /Lounge chair CS3409 P15 / L01
 Abrey Tavolino /Coffee table CS5137-AP15L/ P18C



Quadrotta Poltrona /Lounge chair CS3409 P15 / SWE

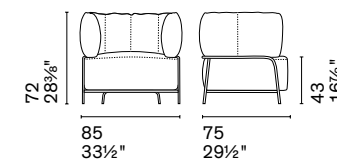

CS3409 1300 MTO

Nota Per le combinazioni disponibili consultare il listino prezzi. /**Note** Please check all available combinations in the price list.



Lounge dalle dimensioni compatte che per la forma elegante ricorda il fiore della calla, Rendez Vous è una poltroncina da conversazione, come suggerisce il nome stesso. Allo schienale sottile e curvo fa da contrappunto un sedile voluminoso, realizzato con una struttura a cinghie elastiche e sostenuto da quattro piedini impreziositi dal dettaglio metallico.

A compact lounge chair with an elegant shape reminiscent of a calla lily, Rendez Vous is a conversation armchair, as the name suggests. The thin and curved backrest is counterbalanced by a voluminous seat, made with an elastic strap structure and supported by four feet embellished with metallic detail.

Rendez Vous



CS3418



Rendez Vous Poltrona / Lounge chair CS3418 P15-P175 / S0Z
 Renee Tavolino / Coffee table CS5133-EP P15 / P18C

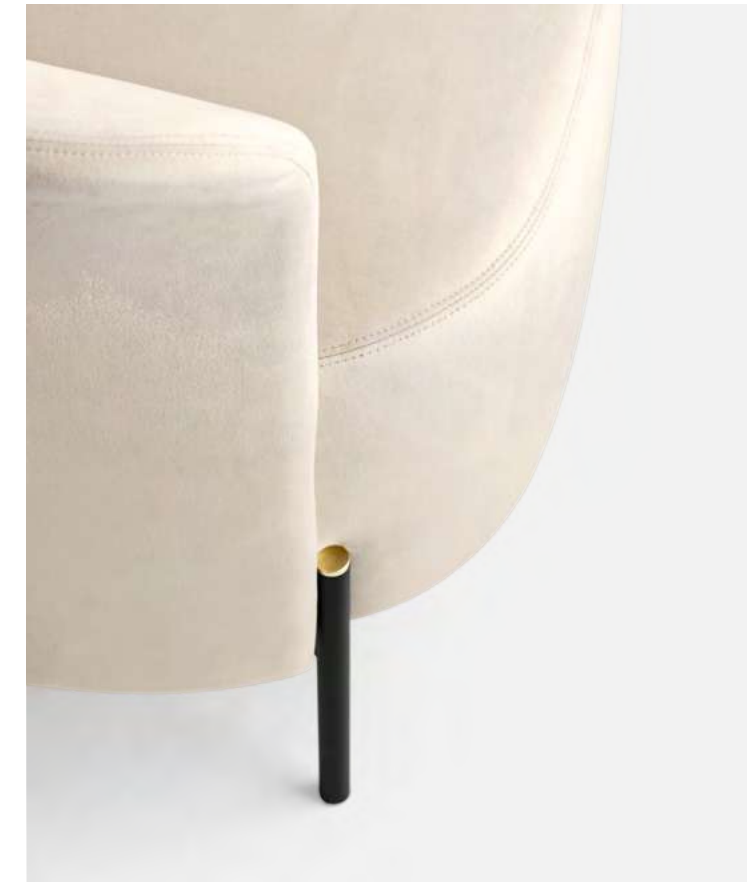

Rendez Vous Poltrona / Lounge chair CS3418 P15-P175 / S0Z

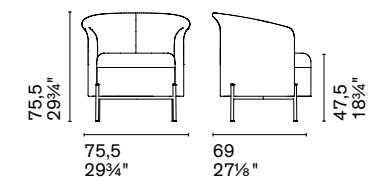

CS3418 1300 MTO

Nota Per le combinazioni disponibili consultare il listino prezzi. / **Note** Please check all available combinations in the price list.



Nella poltrona Rio, le linee curve e generose sono esaltate dall'assenza di spigoli e dalle cuciture d'ispirazione couture. A sollevare la seduta da terra sono quattro piedini in legno arrotondati e levigati, che donano slancio e leggerezza a una poltrona dai volumi esagerati, garanzia di assoluto comfort.

In the Rio armchair, the curved and generous lines are highlighted by the absence of edges and the couture-inspired seams. Four rounded and polished wooden feet lift the seat off the ground, giving dynamism and lightness to an armchair with exaggerated volumes, a guarantee of absolute comfort.

Rio



CS3445

design by Bernhardt & Vella



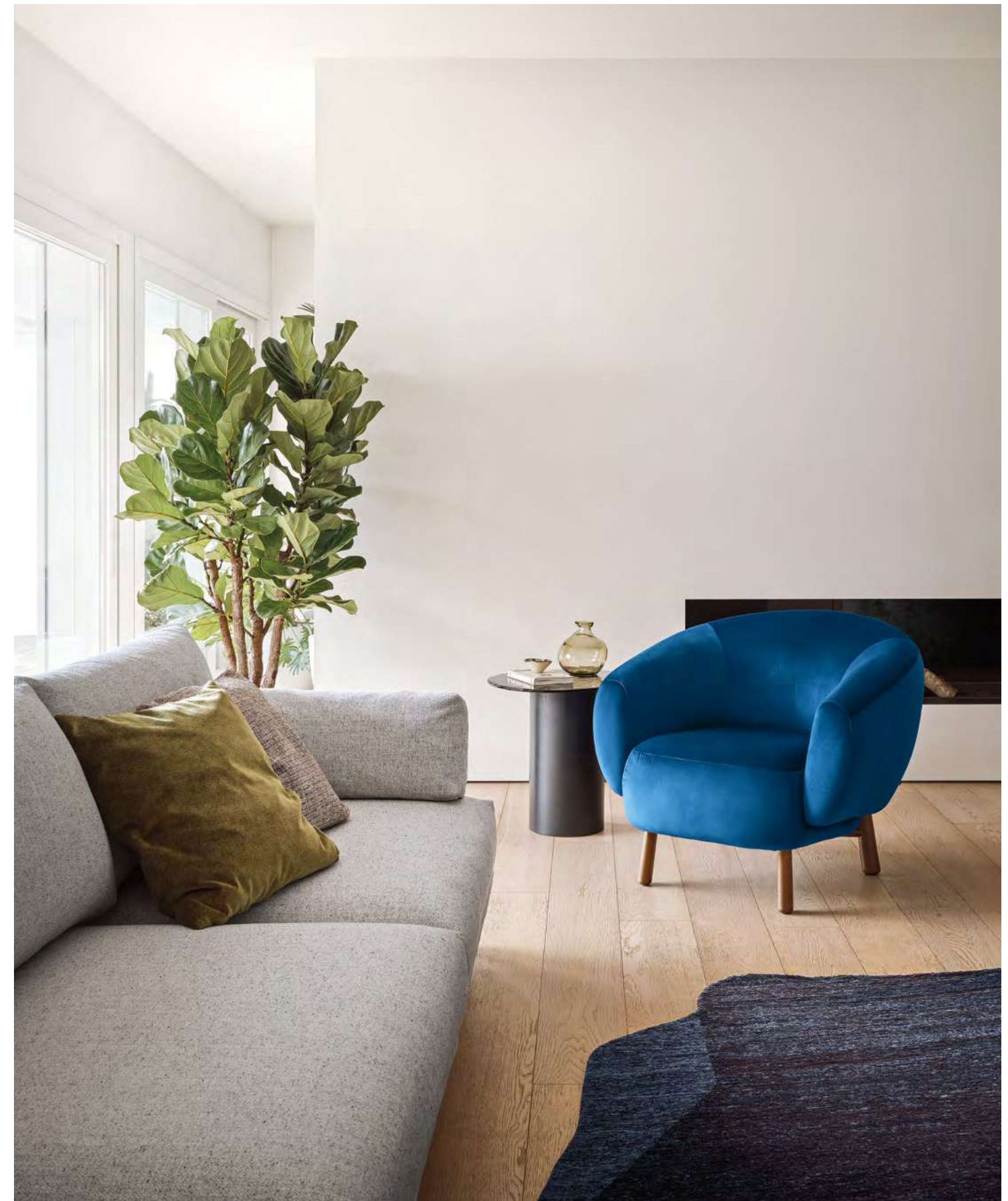

Rio Poltrona / Lounge chair CS3445 P15L / SQM
 Mushroom Tavolino / Coffee table CS5140-A P15L / GM3
 Roche Tappeto / Rug CS7258



Rio Poltrona / Lounge chair CS3445 P15L / SQM

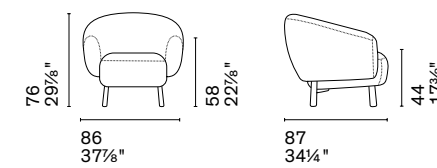

CS3445-DTP1000 MTO

Nota Per le combinazioni disponibili consultare il listino prezzi. / **Note** Please check all available combinations in the price list.



Shape è una panca rivestita in vero cuoio. Per le dimensioni compatte, la seduta leggermente imbottita e le tasche laterali è un complemento che si presta a rispondere a diverse esigenze funzionali. È dunque perfetta in salotto, ma anche in camera da letto o negli spazi contenuti di un ingresso o di una cabina armadio.

Shape is a bench upholstered in genuine leather. Due to its compact size, slightly padded seat, and side pockets, it is a complement that lends itself to many functional needs. It is therefore perfect in the living room, but also in the bedroom or in the confined spaces of an entrance hall or walk-in closet.

Shape



CS5083

design by Pio & Tito Toso



Shape Panca /Bench CS5083 L11



Shape Panca /Bench CS5083 L11

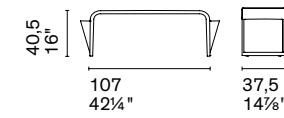

CS5083

Nota Per le combinazioni disponibili consultare il listino prezzi. /**Note** Please check all available combinations in the price list.



Calligaris S.p.A.
Via Trieste, 12
33044 Manzano (UD) Italy
Tel. +39 0432 748 211
calligaris@calligaris.it

Calligaris USA Inc.
P.O. Box 750 High Point,
NC 27261
Phone +1 336 431 5500
highpoint@calligaris.it

Calligaris Japan Y.K.
Kobe Fashion Mart 6W-06
6-9 Koyocho-naka
Higashinada-ku
Kobe 658-0032 Japan
Phone +81 078 854 6120
info@calligaris.co.jp

Calligaris France S.à.r.l.
45, Rue du Bac
75007 Paris, France
export.fr@calligaris.it

Calligaris Retail Limited
177-178 Tottenham Court Road
W1T 7NY, London
United Kingdom
export.uk@calligaris.it

Calligaris Germany GmbH
Lenbachplatz, 6
80333 München
export.trieb@calligaris.it

Calligaris S.p.A.
Representative Office
Business Center «Silver Stone»
Proezd Serebryakova, 14
Bldg. 15, 3rd Floor, Office 328
129343, Moscow, Russia
export.csi@calligaris.it

Campione promozionale gratuito
non destinato alla vendita -
escluso IVA art. 2 comma 3 lettera
C DPR 633/72 - esonerato dalla bolla
di accompagnamento art. 4 punto
6 DPR 627/78
/Free promotional sample - VAT not
included art. 2 par. 3 letter C DPR
633/72 - no transport documents -
required art. 4 item 6 ART 627/78

Copyright ©Calligaris S.p.A.
Tutti i diritti riservati /All rights reserved

Stampa /Print 04.2024

